

iMatrix

4x4 HDMI 2.0 18Gbps Matrix Switcher with Audio

User Manual V1.0

Model: iMatrix H44A



Thank you for purchasing this product

For optimum performance and safety, please read these instructions carefully before connecting, operating or adjusting this product. Please keep this manual for future reference.

Surge protection device recommended

This product contains sensitive electrical components that may be damaged by electrical spikes, surges, electric shock, lightning strikes, etc. Surge protection is highly recommended in order to protect and extend the life of your equipment.

Table of Contents

1. Introduction	3
2. Features	3
3. Package Contents	4
4. Specifications	4
5. Operation Controls and Functions.....	6
5.1 Front Panel.....	6
5.2 Rear Panel.....	6
5.3 Connecting to the Switcher.....	7
5.4 Using the Switcher	7
6. IR Remote.....	8
7. Using the Bulit-In Web GUI Interface.....	9
8. API control command	18
9. Application Example	24

1. Introduction

This high-performance HDMI Matrix Switcher can switch any of these four HDMI 2.0 sources to four HDMI 2.0 displays. Each input and output support up to 4K60 444 resolution and HDCP 2.2. The outputs can be individually scaled for 1080p. De-embedded audio as analog L/R and coaxial is available for both outputs. The ARC function can return display device audio to coaxial port output only. Advanced EDID management is supported. With its 18Gbps bandwidth and the additional features with latest HDMI standards. This switcher can be controlled from the front panel, RS-232, IR remote, or TCP/IP.

2. Features

- ☆ HDMI 2.0, HDCP 2.2 / HDCP 1.4 and DVI 1.0 compliant
- ☆ Four 18G HDMI 2.0 video inputs support up to 4K60 444 resolution
- ☆ Four 18G HDMI 2.0 video outputs support up to 4K60 444 resolution
- ☆ Four outputs can be individually scaled for 4K→1080p
- ☆ De-embedded audio to analog L/R and Coaxial ports output
- ☆ ARC audio return to the coaxial ports output only
- ☆ Built-in Web GUI for TCP/IP control
- ☆ Advanced EDID management supported
- ☆ Four methods of control: Front panel, RS-232, IR remote and TCP/IP
- ☆ Compact design for easy and flexible installation

3. Package Contents

Qty	Item
1	4×4 HDMI 2.0 18Gbps Matrix Switcher
1	12V/2.5A Locking Power Adapter
1	IR Remote
2	Mounting Ears
1	38KHz IR Receiver Cable (1.5 meters)
1	3-pin Phoenix Connector
1	User Manual

4. Specifications

Technical	
HDMI Compliance	HDMI 2.0
HDCP Compliance	HDCP 2.2 and HDCP 1.4
Video Bandwidth	18 Gbps
Video Resolution	4K2K 50/60Hz 4:4:4 4K2K 50/60Hz 4:2:0 4K2K 30Hz 4:4:4 1080p, 1080i, 720p, 720i, 480p, 480i All HDMI 3D TV formats All PC resolutions including 1920 x 1200
Output Scaling	4K to 1080p
3D Support	Yes
Color Space	RGB, YCbCr4:4:4, YCbCr4:2:2, YCbCr 4:2:0
Color Depth	8-bit, 10-bit, 12-bit [1080P, 4K30Hz, 4K60Hz (YCbCr 4:2:0)] 8-bit [4K60Hz (YCbCr 4:4:4)]
HDMI Audio Formats	PCM2.0/5.1/7.1CH, Dolby Digital/Plus/EX, Dolby True HD, DTS, DTS-EX, DTS-96/24, DTS High Res, DTS-HD Master Audio, DSD



Coaxial Audio Formats	PCM2.0, Dolby Digital / Plus, DTS 2.0/5.1		
L/R Audio Formats	PCM2.0CH		
HDR Support	HDR10, HDR10+. Dolby Vision, HLG		
ESD Protection	Human-body Model: $\pm 8\text{kV}$ (Air-gap discharge), $\pm 4\text{kV}$ (Contact discharge)		
Connections			
Input Ports	4×HDMI Type A [19-pin female]		
Output Ports	4×HDMI Type A [19-pin female] 4×L/R audio out [3.5mm Stereo Mini-jack] 4×COAX audio out [RCA]		
Control ports	1x TCP/IP [RJ45] 1x RS-232[3-pin phoenix connector] 1x IR EXT [3.5mm Stereo Mini-jack]		
Mechanical			
Housing	Metal Enclosure		
Color	Black		
Dimensions	220mm (W)×105mm (D)×44mm (H)		
Weight	792g		
Power Supply	Input: AC100~240V 50/60Hz Output: DC12V/2.5A (Locking connector)		
Power Consumption	10W (max), 1.56W (Standby)		
Operating Temperature	0°C ~ 40°C / 32°F ~ 104°F		
Storage Temperature	-20°C ~ 60°C / -4°F ~ 140°F		
Relative Humidity	20~90% RH (non-condensing)		
Resolution / Cable Length	4K60 - Feet / Meters	4K30 - Feet / Meters	1080P60 - Feet / Meters
HDMI IN / OUT	10ft / 3M	30ft / 10M	42ft / 15M
The use of "Premium High Speed HDMI" cable is highly recommended.			

5. Operation Controls and Functions

5.1 Front Panel

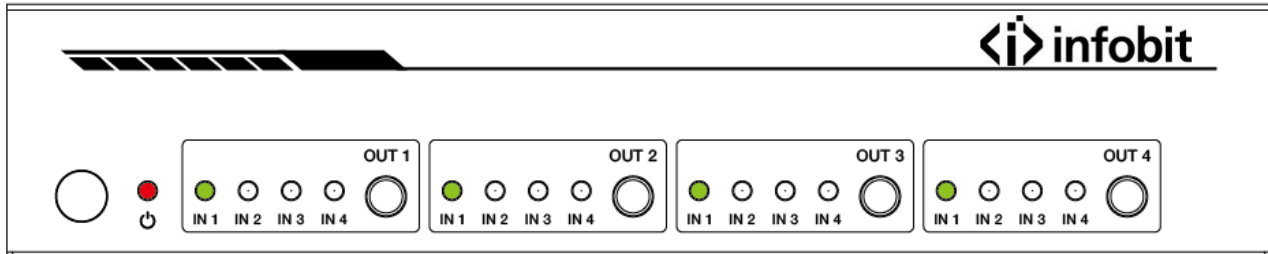

Name	Function description
IR Sensor	IR input for remote control of the switcher.
POWER LED	Red LED indicates that the unit is powered.
OUT 1 / OUT 2 / OUT 3 / OUT 4 Button	Press to select the desired input.
IN 1 IN2 / IN3 / IN4 LED	Green LED indicates when the input is selected for respective output.

5.2 Rear Panel

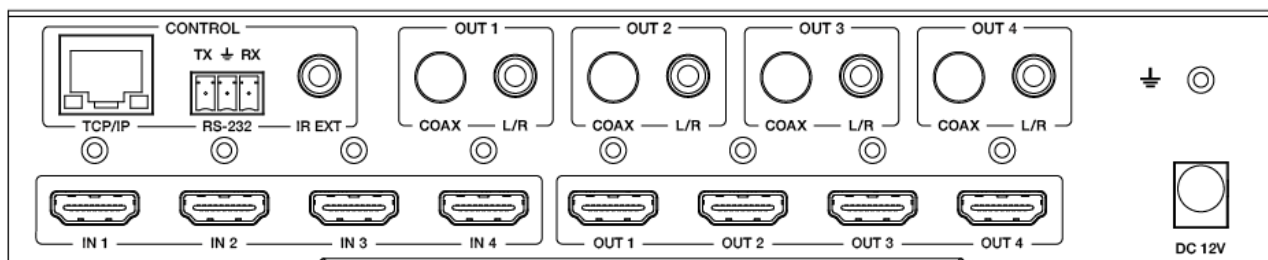

Name	Function description
TCP/IP (RJ45)	Control port for TCP/IP control or accessing the built-in Web GUI.
RS-232	3-pin pluggable connector for RS-232 control of the Switcher.
IR EXT	IR eye input for IR control of the Switcher.



Coaxial Audio OUT 1 / OUT 2 / OUT 3 / OUT 4	RCA connector for coaxial audio output from HDMI OUT 1 / OUT 2 / OUT 3 / OUT 4.
L/R Audio OUT 1 / OUT 2 / OUT 3 / OUT 4	3.5mm Mini-jack connector for stereo audio output from HDMI OUT 1 / OUT 2 / OUT 3 / OUT 4.
Earthing Point	Screw terminal for earthing the Switcher.
HDMI Input 1 to 4	HDMI Source inputs 1 to 4.
HDMI Output 1 to 4	HDMI outputs for displays 1 to 4.
DC 12V IN	DC 12V input for 12V 2.5A PSU.

5.3 Connecting to the Switcher

1. Connect the desired HDMI input sources.
2. Connect the desired HDMI display devices.
3. Connect any CONTROL inputs that may be required: TCP/IP, RS-232 or IR IN.
4. Connect any audio devices to either the Coaxial or L/R outputs.
5. Connect the 12V DC PSU.

5.4 Using the Switcher

5.4.1 Power LED and Standby Mode

The Power LED provides the following indications:

Color	Description
Red	The Switcher is active and fully controllable
Off	The Switcher is in standby mode, this state can be changed by using API commands or IR

Remote, or from the Web GUI interface.

5.4.2 Selecting Inputs

Manual Selection of the inputs is done by briefly pressing the OUT 1 / OUT 2 / OUT 3 / OUT 4 button repeatedly for that channel until the desired input is selected.

6. IR Remote

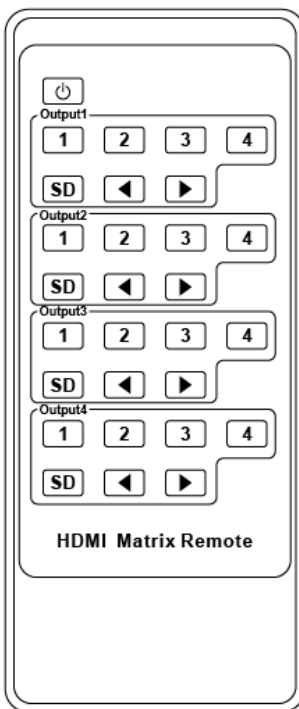

	Power on the Switcher or set it to standby mode.
Output 1 (Output 2 / 3 / 4)	
1/2/3/4	Select the desired input source to Output 1 port output, the corresponding green LED on the front panel illuminates.
SD	Switch downscale or bypass mode to the Output 1 port output.



Select the last or next the desired input source to Output 1 port output, the corresponding green LED on the front panel illuminates.

7. Using the Built-In Web GUI Interface

The Switcher has a built-in Web interface to provide a means of controlling or configuring various settings. There are six pages available, each of which will be outlined in detail in the following sections:

The six pages are:

1. **Status** – Display information about the firmware and IP setting.
2. **Video** – Switch the desired input source to output and set the preset.
3. **Input** – Display information about the input signal and EDID setting.
4. **Output** – Display information about the output signal and scaler option.
5. **Network** – Allow basic network setting management and login options.
6. **System** – Panel lock, beep, serial baudrate setting and firmware update.

Note these six pages are only accessible in Admin mode, when User mode is used only the Status and Video pages are available.

To access the Web interface, enter the IP address of the switcher into the address bar of any web browser. The default IP address is **192.168.1.100**.

Please see the following operation method.

Note that if the IP address of the switcher is not know, use the RS-232 command given in the Network Setting section “**r ip addr!**” to discover the current IP address or set the switcher to factory default status and IP address restores to default 192.168.1.100.

Step 1: The TCP/IP port on the rear panel is directly connected a PC with an UTP cable.

Step 2: Set your PC IP address to the same network segment with Switcher, for instance set PC IP address to 192.168.1.200 and Subnet mask to 255.255.255.0.

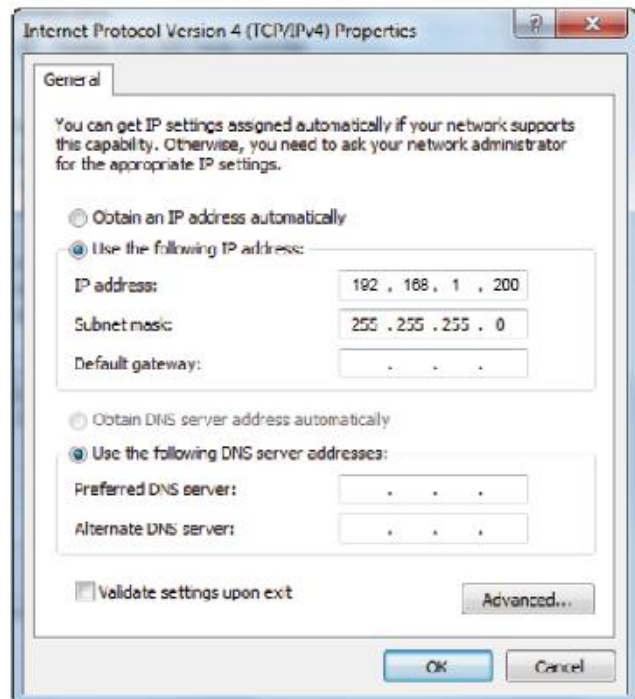
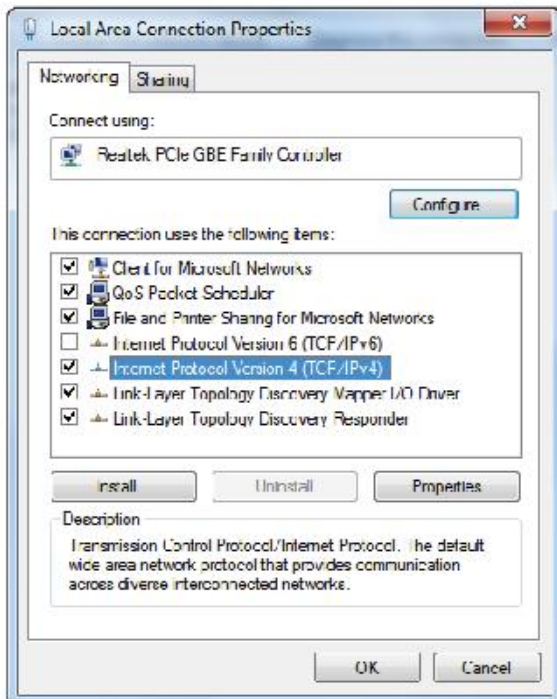

Step 3: Enter the Switcher's IP address into your browser on the PC to enter

Web GUI page.

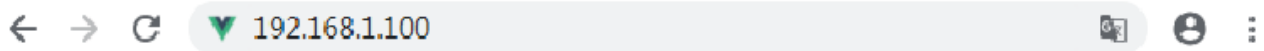

After entering the IP address the following log in screen will appear:



Select the Username from the list and enter the password. The default passwords are:

Username	User	Admin
Password	user	admin

After entering the log in details, click the LOGIN button and the following Status page will appear.

■ Status page

The Status page provides basic information about the product Model name, the installed firmware version and the network setting. This page is visible in both User and Admin modes.



The screenshot shows the infobit web interface for a 10Gbps 4x4 HDMI & Matrix switch. The top navigation bar includes the infobit logo, the product name, and user controls for Admin, Log out, and Stand by. The left sidebar contains navigation options: Status (selected), Video, Input, Output, Network, and System. The main content area displays the Status page with the following information:

Status	
Model	HDP-MXB44P
Firmware Version	v1.00.01/1.37
Hostname	IP-module
IP Address	192.168.1.100
Subnet Mask	255.255.255.0
Gateway	192.168.1.1
Mac Address	6C:DF:FB:02:11:D6

The buttons at the top right of the web interface are always available and provide the following function:

- The **Log out** button will disconnect the current user from display the log in screen.
- The **Power on** button changes the power status of the Switcher between On and Stand-by mode.

■ Video page

The Video page allows selection of the inputs source and set the presets.

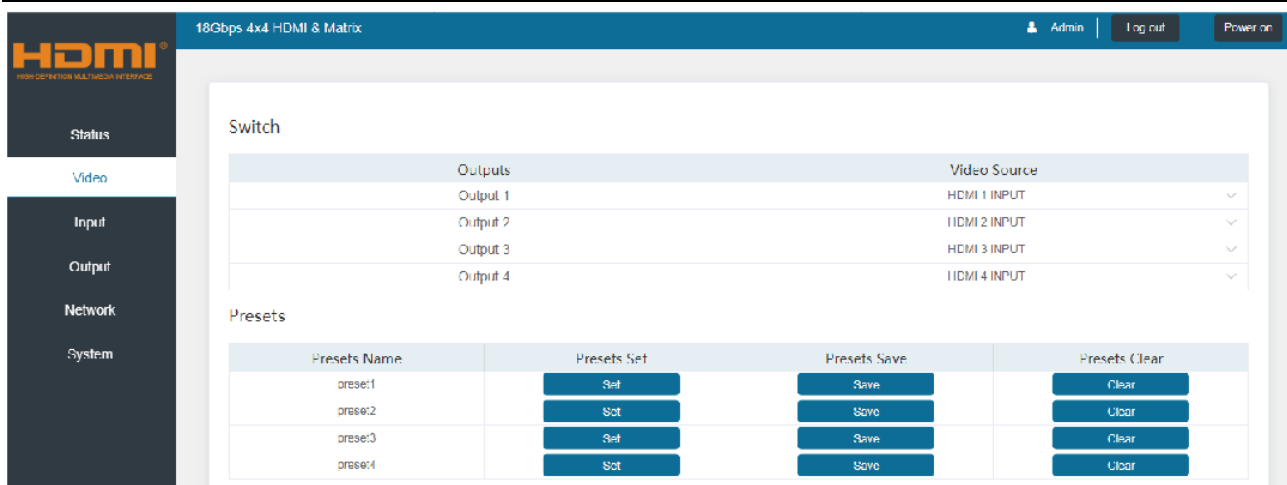

The screenshot shows the infobit web interface for a 18Gbps 4x4 HDMI & Matrix switch. The top navigation bar includes the infobit logo, the device name '18Gbps 4x4 HDMI & Matrix', and user options: 'Admin', 'Log out', and 'Power on'. A left sidebar contains menu items: 'Status', 'Video', 'Input', 'Output', 'Network', and 'System'. The main content area is divided into two sections: 'Switch' and 'Presets'.

Switch Section:

Outputs	Video Source
Output 1	HDMI 1 INPUT
Output 2	HDMI 2 INPUT
Output 3	HDMI 3 INPUT
Output 4	HDMI 4 INPUT

Presets Section:

Presets Name	Presets Set	Presets Save	Presets Clear
preset:1	Set	Save	Clear
preset:2	Set	Save	Clear
preset:3	Set	Save	Clear
preset:4	Set	Save	Clear

To this preset setting, first you need to select the desired input source to four output ports. Then click the **Save** button to save the setting. When you click the line **Set** button, this preset you have saved will be used. The **Clear** button will clear the preset. There are four presets setting available.

■ Input page

The Input page provides information about which inputs are connected and have a signal present. The inputs can be giving more meaningful names, if desired. The EDID column provides a list of EDID options for each individual input.

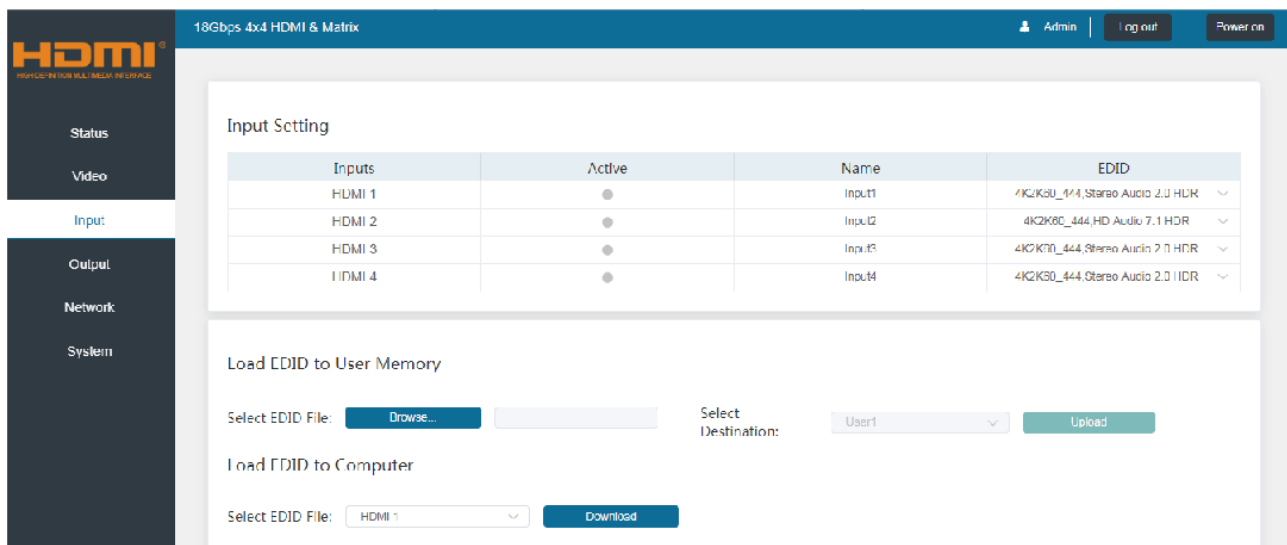

The following EDID options are available in any of the EDID drop-down lists:

1080P, Stereo Audio 2.0

1080P, Dolby/DTS 5.1

1080P, HD Audio 7.1

1080I, Stereo Audio 2.0

1080I, Dolby/DTS 5.1

1080I, HD Audio 7.1

3D, Stereo Audio 2.0

3D, Dolby/DTS 5.1

3D, HD Audio 7.1

4K2K30Hz_444 Stereo Audio 2.0

4K2K30Hz_444 Dolby/DTS 5.1

4K2K30Hz_444 HD Audio 7.1

4K2K60Hz_420 Stereo Audio 2.0

4K2K60Hz_420 Dolby/DTS 5.1

4K2K60Hz_420 HD Audio 7.1

4K2K60Hz_444 Stereo Audio 2.0

4K2K60Hz_444 Dolby/DTS 5.1

4K2K60Hz_444 HD Audio 7.1

4K2K60Hz_444 Stereo Audio 2.0 HDR

4K2K60Hz_444 Dolby/DTS 5.1 HDR

4K2K60Hz_444 HD Audio 7.1 HDR

USER_1

USER_2

COPY_FROM_TX_1

COPY_FROM_TX_2

COPY_FROM_TX_3

COPY_FROM_TX_4

This page also provides a means of sending a binary EDID file to either

User 1 or **User 2** EDID memories:

1. Select the binary EDID file on your PC by click on the **Browse** button.
2. Select either **User 1** or **User 2** from the drop-down list.
3. Click the **Upload** button.

The EDID data from any input or from the **User 1** and **User 2** locations can be read and stored on your PC.

■ Output page

The outputs can also be assigned meaningful names, if desired. The Output page provides information about the signal status of the outputs.

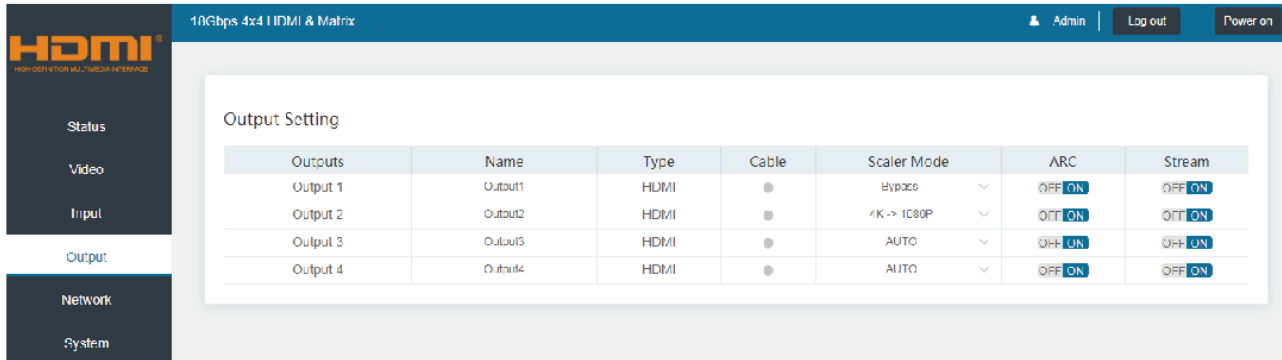

The **Scaler** mode menu provides the following options:

Bypass	Follow the input source. (Pass-through)
4K → 1080P	Downscale to 1080p, if needed.
AUTO	Scaler to match the display requirements.

The **ARC** buttons enable or disable the display device audio to the coaxial audio outputs. If the ARC function enables, the L/R audio port will have no voice output simultaneously.

The **Stream** buttons enable or disable the output signal for the respective output.

■ Network page

The Network page allows the configuration of the network settings.

*Note that the IP address boxes are only accessible when the **Mode** button is set to **Static**.*

The log in passwords can be changed on this page.

Note that any changes to this page will require the new details into the web browser and/or the log in screen.

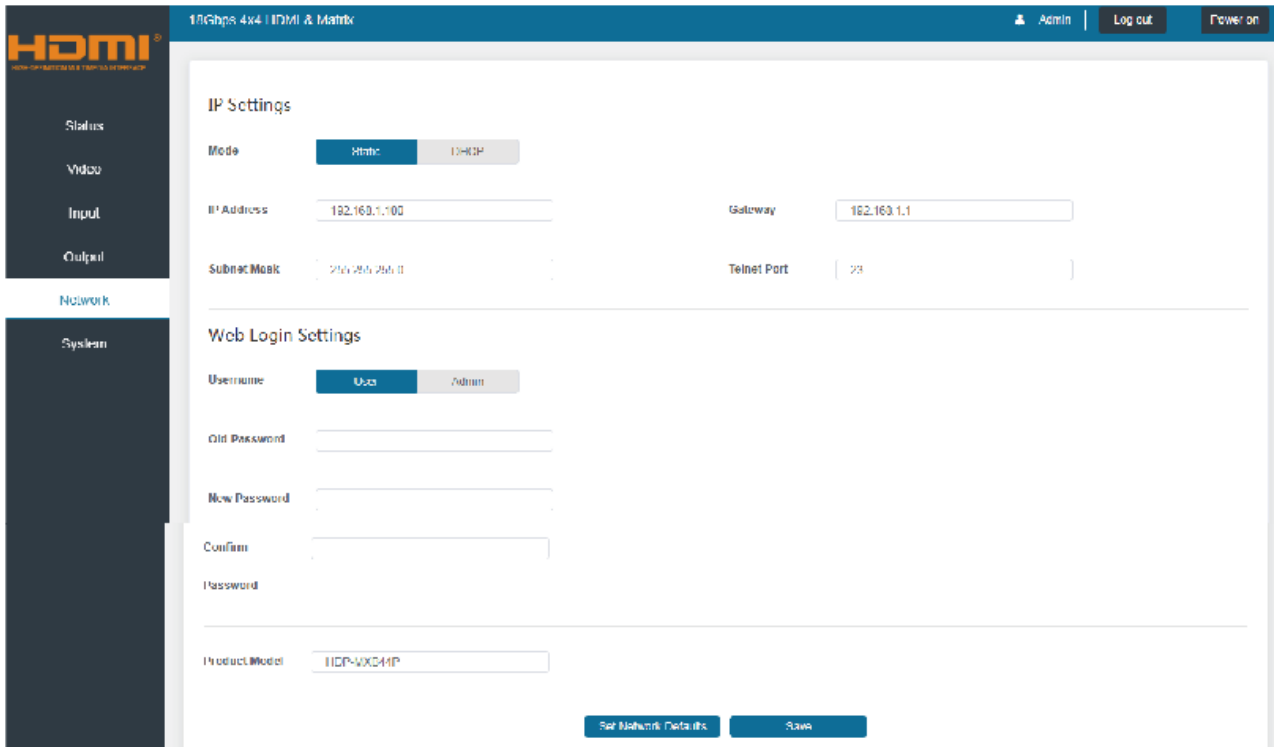

■ System page

The system page allows setting of the panel lock and beep on/off, control RS-232 port baud rate.

This page is also used to install new firmware update, restore the factory default settings and reboot the Switcher.

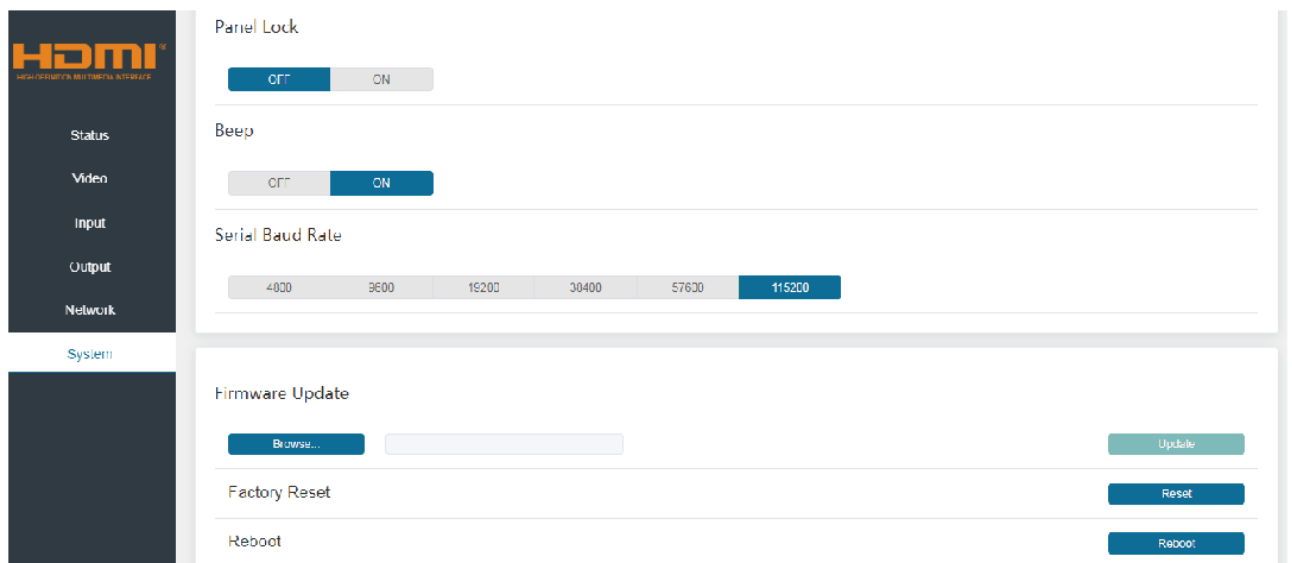

8. API control command

The Switcher can also be controlled by RS-232. Connect a PC by using a serial cable and open any of a Serial Command tool on the PC such as **Comm Operator**, **Docklight** or **hercules**, etc to send command for controlling the Switcher. Please see the following connection diagram.

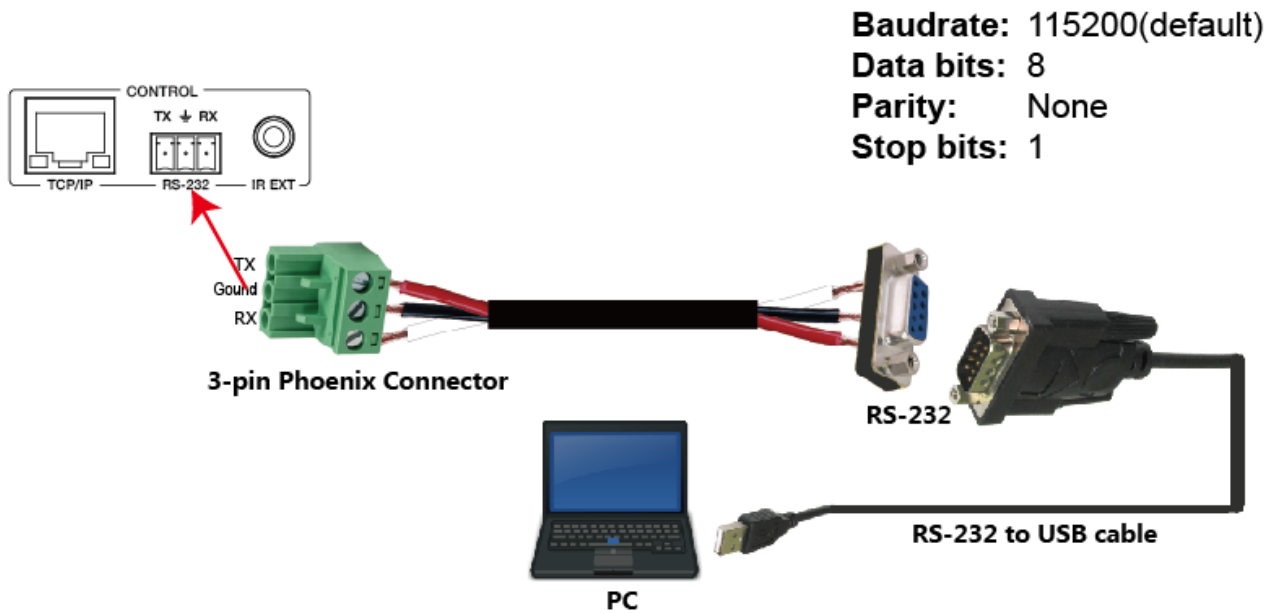

Figure 1: 3-pin phoenix connector to USB

Important:

1. All messages sent to the Switcher must be terminated with an exclamation mark (!). Any carriage return that is present after the end of the command will be ignored.
2. All spaces shown in the commands are required.
3. All response messages are terminated by a CR/LF sequence.
4. When all four inputs are requested by the same command, the response will report each input on a separate line.
5. When four outputs are requested by the same command, the response will report each output on a separate line.

The ASCII list about the product is shown as below.

ASCII Command
Serial port protocol: Baud rate: 115200 (default), Data bits: 8bit, Stop bits:1, Check bit: None



TCP/IP protocol port: 8000

The x, y, z and XXX are parameters.

RS-232Command	Function description	Feedback
Power		
s power z!	power on/off the device,z=0~1(z=0 power off, z=1 power on)	power on System Initializing... Initialization Finished! power off
r power!	get current power state	power on /power off
s reboot!	reboot the device	Reboot... System Initializing... Initialization Finished!
SYSTEM Setup		
help!	Lists all commands	
r type!	Get device model	HDP-MXB44P
r status!	Get device current status	Get the unit all status: power, beep, lock, in/out connection, video/audio crosspoint, edid, scaler,hdcp, network status
r fw version!	Get Firmware version	MCU FW version x.xx.xx
r link in x!	Get the connection status of the x input port,x=0~4(0=all)	HDMI IN1: connect
r link out y!	Get the connection status of the y output port, y=0~4(0=all)	HDMI OUT1: connect
s reset!	Reset to factory defaults	Reset to factory defaults System Initializing... Initialization Finished!
s beep z!	Enable/Disable buzzerfunction,z=0~1(z=0 beep off, z=1 beep on)	beep on / beep off
r beep!	Get buzzer state	beep on / beep off
s lock z!	Lock/Unlock front panelbutton,z=0~1(z=0 lock off,z=1 lock on)	panel button lock on panel button lock off
r lock!	Get panel button lock state	panel button lock on/off



s save preset z!	Save switch state between all output port and the input port to preset z, z=1~8	save to preset 1
s recall preset z!	Call saved preset z scenarios, z=1~8	recall from preset 1
s clear preset z!	Clear stored preset z scenarios,z=1~8	clear preset 1
r preset z!	Get preset z information, z=1~8	video/audio crosspoint
s baud rate xxx!	Set the serial port baud rate of RS02 module,z=(115200,57600,38400,19200,9600,4800)	Baudrate:115200
r baud rate!	Get the serial port baud rate of RS02 module	Baudrate:115200
s id z!	Set the control ID of the product, z=000~999	id 888
Output Setting		
s in x av out y!	Set input x to output y, x=1~4, y=0~4(0=all)	input 1 -> output 2
r av out y!	Get output y signal status y=0~4(0=all)	input 1 -> output 1 input 2 -> output 2 input 4 -> output 4
s out y stream z!	Set output y stream on/off, y=0~4(0=all) z=0~1(0:disable,1:enable)	Enable out 1 stream Disable out 1 stream
r out y stream!	Get output y stream status, y=0~4(0=all)	Enable out 1 stream
s hdmi y scaler z!	Set hdmi output y port output scaler mode, y=0~4(0=all), z=1~3(1=bypass,2=4k->1080p,3=Auto)	hdmi 1 set to bypass mode
r hdmi y scaler !	Get hdmi output y port output mode y=0~4(0=all)	hdmi 1 set to bypass mode
s hdmi y hdcp z!	Set hdmi output y port hdcp status y=0~4(0=all) z=0~1(1=active,0=off)	hdmi 1 hdcp active
r hdmi y hdcp!	Get HDCP status of HDMI out y, y=0~4(0=all)	hdmi 1 hdcp active
Audio Setting		
s hdmi y arc z!	Turn on/off arc of HDMI output y, y=0~4(0=all) z=0~1(z=0,off,z=1 on)	hdmi output 1 arc on hdmi output 1 arc off
r hdmi y arc!	Get the arc state of HDMI output y, y=0~4(0=all)	hdmi out1 arc on
EDID Setting		
r edid in x!	Get EDID status of the input x, x=0~4(0=all inputs)	IN1 EDID: 4K2K60_444, Stereo Audio 2.0 IN2 EDID: 4K2K60_444,



		<p>Stereo Audio 2.0</p> <p>IN3 EDID: 4K2K60_444, Stereo Audio 2.0</p> <p>IN4 EDID: 4K2K60_444, Stereo Audio 2.0</p>
r edid data hdmi y!	Get the EDID data of the hdmi output y port, y=1~4	EDID : 00 FF FF FF FF FF FF 00
s edid in x from z!	<p>Set input x EDID from default EDID z, x=0~4(0=all),z=1~23</p> <ol style="list-style-type: none"> 1、 1080p,Stereo Audio 2.0 2、 1080p,Dolby/DTS 5.1 3、 1080p,HD Audio 7.1 4、 1080i,Stereo Audio 2.0 5、 1080i,Dolby/DTS 5.1 6、 1080i,HD Audio 7.1 7、 3D,Stereo Audio 2.0 8、 3D,Dolby/DTS 5.1 9、 3D,HD Audio 7.1 10、 4K2K30_444,Stereo Audio 2.0 11、 4K2K30_444,Dolby/DTS 5.1 12、 4K2K30_444,HD Audio 7.1 13、 4K2K60_420,Stereo Audio 2.0 14、 4K2K60_420,Dolby/DTS 5.1 15、 4K2K60_420,HD Audio 7.1 16、 4K2K60_444,Stereo Audio 2.0 17、 4K2K60_444,Dolby/DTS 5.1 18、 4K2K60_444,HD Audio 7.1 19、 4K2K60_444,Stereo Audio 2.0 HDR 20、 4K2K60_444,Dolby/DTS 5.1 HDR 21、 4K2K60_444,HD Audio 7.1 HDR 22、 USER1 23、 USER2 24、 Copy_From_Hdmi_Tx_1 25、 Copy_From_Hdmi_Tx_2 	<p>IN1 EDID:1080p,Stereo Audio 2.0</p>



	26、Copy_From_Hdmi_Tx_3 27、Copy_From_Hdmi_Tx_4	
Network setting		
r ipconfig!	Get the Current IP Configauration	IP Mode: Static, IP: 192.168.1.72 Subnet Mask: 255.255.255.0, Gateway: 192.168.1.1 Mac address: 00:1C:91:03:80:01 TCP/IP port=8000, telnet port=10
r mac addr!	Get network MAC address	Mac address: 00:1C:91:03:80:01
s ip mode z!	Set network IP mode to static IP or DHCP, z=0~1 (z=0 Static, z=1 DHCP)	Set IP mode:Static. Please use "s net reboot!" command or repower device to apply new config!
r ip mode!	Get network IP mode	IP mode: Static
s ip addr xxx.xxx. xxx.xxx!	Set network IP address	Set IP address:192.168.1.100 Please use "s net reboot!" command or repower device to apply new config! DHCP on, Device can't config static address, set DHCP off first.
r ip addr!	Get network IP address	IP address:192.168.1.100
s subnet xxx.xxx. xxx.xxx!	Set network subnet mask	Set subnet Mask:255.255.255.0 Please use "s net reboot!" command or repower device to apply new config! DHCP on, Device can't config subnet mask, set DHCP off first.
r subnet!	Get network subnet mask	Subnet Mask:255.255.255.0
s gateway xxx.xxx. xxx.xxx!	Set network gateway	Set gateway:192.168.1.1 Please use "s net reboot!" command or repower device to apply new config! DHCP on, Device can't config gateway, set DHCP off first.



r gateway!	Get network gateway	Gateway:192.168.1.1
s tcp/ip port x!	Set network TCP/IP port (x=1~65535)	Set tcp/ip port:8000
r tcp/ip port!	Get network TCP/IP port	tcp/ip port:8000
s telnet port x!	Set network telnet port(x=1~65535)	Set telnet port:23
r telnet port!	Get network telnet port	telnet port:23
s net reboot!	Reboot network modules	Network reboot... IP Mode: Static IP: 192.168.1.72 Subnet Mask: 255.255.255.0 Gateway: 192.168.1.1 Mac address: 00:1C:91:03:80:01 TCP/IP port=8000 telnet port=10

Note that you can send 'RS232 command' to control the Switcher via Serial Command tool. The 'Function description' explains function about the command. The "Feedback" displays whether the command sends success or not and feedback the information you need to.

9. Application Example

