

iVoice 210 Video Phone

User Manual



www.infobitav.com
info@infobitav.com

Version Description

Version No.	Edit Date	Editor	Description
	June 21, 2021		V1.0
	April 01, 2022		

Catalogue

1 Installation requirement	5
2 Get Started	5
3 Device Introduction	6
3.1 Overview	6
3.2 Features	7
3.3 Button and keys	8
3.4 Ports	9
3.5 Specification	10
3.6 Indicator	12
4 Configuration	12
4.1 Basic configuration	12
4.1.1 Touch screen Operation	13
4.1.2 Power on/off	14
4.1.3 Home interface	15
4.2 Network Setting	17
4.2.1 DHCP	17
4.2.2 Static IP	19
4.2.3 Wi-Fi	20
4.2.4 Wi-Fi AP	22
4.3 VOIP Setting	23
4.3.1 SIP Account Setting	23
4.3.2 Call Setting	27
4.4 Bluetooth Settings	33
4.5 Display Setting	35
4.6 Sound	36
4.7 Date & Time	38
4.8 Language	39
4.9 Security	40
4.10 Advanced Setting	41
4.11 About	42
5 How to use	43

5.1 Call function	43
5.1.1 Dial numbers.....	43
5.1.2 Incoming calls.....	46
5.1.3 Explanation of function buttons during calls	50
5.1.4 Call Log.....	56
5.1 Contacts	63
5.2.1 Contacts	63
5.2.2 Enterprise contact	73
5.2.3 Mobile Contact.....	74
5.2.4 Favorite Contacts	77
5.2.5 Group	80
5.2.6 Black List and White List.....	82
5.2.7 Contacts Operating Options	82
5.3 Other Application	84
5.3.1 One-key to Lock.....	84
5.3.2 File Manager	84
5.3.3 Gallery.....	86
5.3.4 Input Method Editor.....	86
5.3.5 Install Third-party Application	87
6 FAQ	88

1 Installation requirement

➤ **Reminder**

- ✧ Please read this User Manual carefully before installing and using this device.
- ✧ Please contact us if any issue during using this device.
- ✧ Please ensure this device working in the temperature range of 0°C~45°C.

➤ **Suggestions**

For safety installation and use, we suggest:

- ✧ Please do not place the device close to water, please do not let any liquid enter the device.
- ✧ Please keep device away from the heat source.

➤ **Power requirement**

- ✧ Power supply must meet the requirements of this manual.

2 Get Started

Thanks for use our iVoice 210 Smart Video Phone. Please read the user manual before

use this device. In this user manual, we will introduce the specification, features, configuration and troubleshooting.

3 Device Introduction

3.1 Overview



This video phone is a high-end media video phone with OCTA Core, 64 bit CPU. Carrying with Android 7.1 operating system, 1280x800 10-inches LCD screen and 8MP camera, it has a great performance in various scenarios. It can support 1080P dual stream video call, support HDMI screen sharing, WIFI screen sharing, double-screen differential displaying, etc., which will help different use in video call and video conference. Be strong in contact function, SDK for third-party application to integrate, this device is good for office use and other industry use.

3.2 Features

✧ Standard communicate protocol

Support SIP protocol, strong in extensibility and compatibility, can communicate with different IMS/Soft switch platform.

✧ HD Video

Build-in 1280x800 pixel, multi-touch 10-inch IPS screen, and 8MP camera, support 1080P Dual Stream, can send HD Main Stream and HD Sub Stream at the same time.

✧ Rich Audio/Video Codec

Support rich codecs including G.711A, G.711U, G.722, AMR, G.729A/AB, G726, OPUS, iLBC, AAC-LD H.264, etc.

✧ Strong contact function

Support Enterprise Contact, Mobile Contact, Local Contact. Support functions including fuzzy search, add/edit/delete/import/export local contacts. Support black/white list, collector, group etc.

✧ Multiple Network Applications

Support static IP, DHCP IP access mode, fully application to various network environments. Support FTP file sharing, WIFI screen sharing, WIFI hotspots, etc.

✧ Rich interfaces

This device has two HDMI ports, one for HDMI in and another for HDMI out. Two Ethernet ports, WAN for uplink, LAN for downlink. One headphone port,

one USB, one SD/TF card port.

3.3 Button and keys

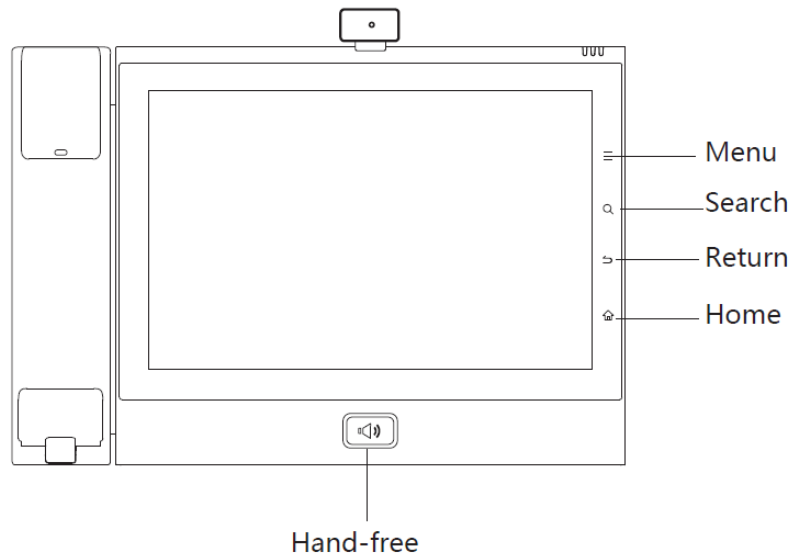

- Menu key: tap menu key to set wallpaper/add widgets
- Search key: tap search key to enter the searching interface of contact list.
- Return key: tap return key to return back to the last interface
- Home key: tap home key to back to home interface. Long-term press the home key to capture the screenshot
- Hand-free button: tap hand-free button in power-on status, to enter the dialer interface, and use hand free function.

3.4 Ports

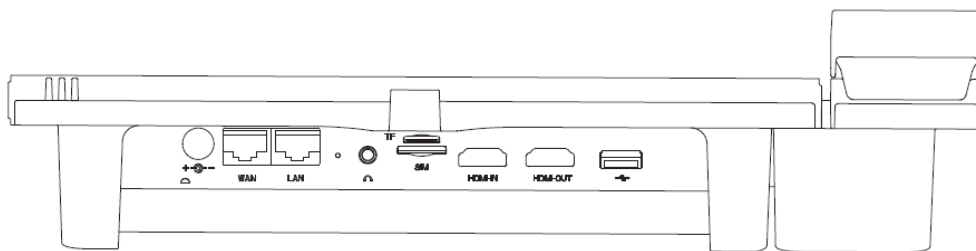
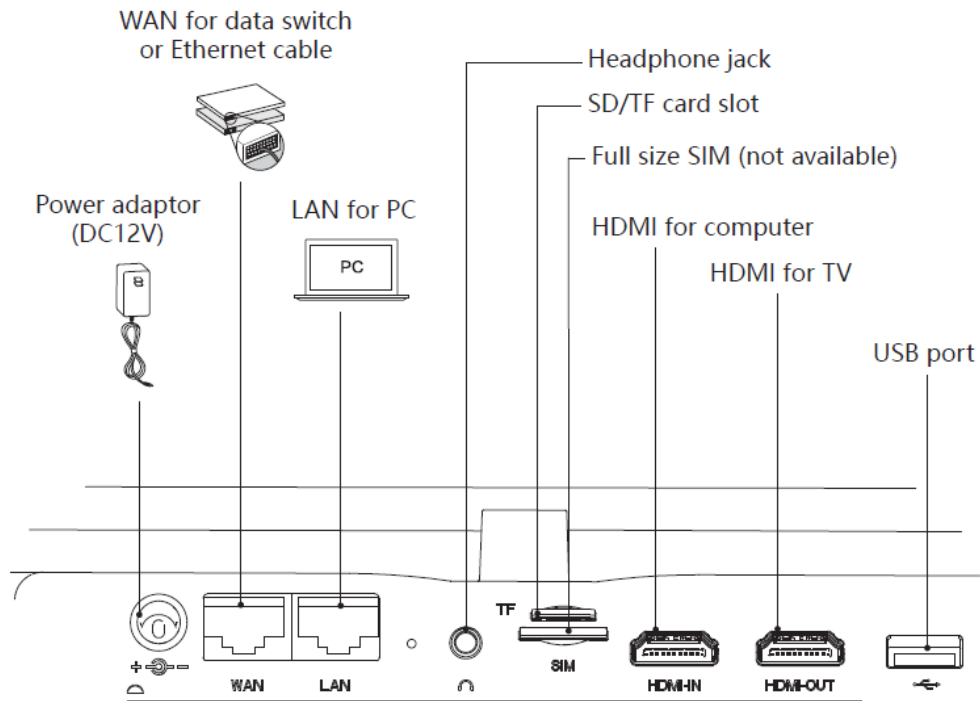

3.5 Specification

Items		Video Phone
System	OS	Android 7.1
	CPU	OCTA core, 64 bit, 2GHz
	FLASH	16GB, eMMC
	RAM	2GB, DDR3
Screen Size		10.1", 1280x800, IPS multi touch screen
Camera		8 mega-pixel, angle adjustable
Display Angle Adjustment		Display angle adjustable from 10~70 degree
Ethernet Port		2 Ethernet ports, 10M/100M/1000M, adaptive; POE (Optional)
HDMI		Two HDMI ports, support HDMI-in and HDMI-out, can support sharing screen and input video auxiliary stream at the same time
Wireless Screen Sharing		1080p@30
WLAN		2.4G/5.8G Dual WIFI, IEEE802.11b/g/n/ac support AP and WLAN features
Bluetooth		BT2.1+EDR/3.0/4.1LE
Storage Card		1 Micro SD (TF)
USB Port		1 USB2.0, support U disk, headphone, keyboard, mouse
Handset Port		RJ-9
Headphone Port		One 3.5mm/Bluetooth headphone/USB headphone
Network Protocol		SIP, TCP/IP, SIP, SDP, UDP, RTP, RTCP, DHCP, DNS HTTP, HTTPS, SNTP, XCAP, IPv4, IPv6
Audio	Audio Protocol	G.711a/G.711u/G.729/G.722/iLBC/SILK/OPUS/ACC/AMR-WB

	Audio Codec	DTMF, AEC, PLC, AGC, VAD, CNG, AJB, ANR, VQM, Side tone Cancellation
	Voice Record	Support
Video	Video Codec	Encoding: H.264, VP8 Decoding: H.264, VP8, H265, MPEG-4
	Video Resolution	QVGA (320 x 240) , CIF (352x288) , VGA (640x480) , 4CIF (704x576) , 720p (1280x720) , 1080p(1920 x 1080)
	Video Display	Full screen show in opposite end, Preview in local side with both showing and preview screen.
	Video Conference	Support China Mobile Cloud Video Conference Platform Support local/UC portal to launch conference Video output of mainstream and auxiliary stream (1080P@30 Dual Streams) Video input of mainstream and auxiliary stream (1080P@30 Dual Streams) Support same display in two screens, Support different display in two screens. Conference operating in local side
Telephony	Contacts	2000 contacts, support contacts search, import, export
	Call Logs	1000 call logs for received calls, 1000 call logs for missed calls, 1000 call logs for dialed numbers
	Local Conference	6 parties audio conference
	Telephony Features	Call Hold, Call Forward, Call Transfer, Three-Way Calling, Call Waiting, Call Reject, Call ID, Missed Call Reminder, Speed Dial
	Line & SIP Account	4 lines, 4 accounts
	Android OS Features	Build-in APP: clock, gallery, web browser, search
Security		TLS, SRTP(AES128)
Management		WEB/TR069
Customized Applications		SDK/API for customer application development. Build-in company contacts
Power Adapter		Input: AC100 ~ 220V Output: DC12V/1.5A

Size

300mm*200mm*72mm

3.6 Indicator

The device indicator on right top side, status shows as below

Status of Indicator	Descriptions
Light off	Device on standby and SIP account is working
Red light on	Network disconnect or SIP account is error
Red light twinkle	Missed call
Green light on	On calling
Green light twinkle	Incoming call, ringing
Blue light on	Disturbance-free mode is on

4 Configuration

This part mainly introduces the configuration method of this device, will tell the method of basic, voice, network, etc. setting.

4.1 Basic configuration

This basic configuration.

4.1.1 Touch screen Operation

✧ Tap

Please tap the touch screen to use the soft key, application, option choosing, button press.

✧ Long press

If want to enable any application options, just need to long press this application until its option show.

✧ Drag

Long press and drag application to somewhere you want, keep press it during drag it. For example, if you want to put this application into Recycler, just keep press and drag it to recycler.

✧ Slide

Slide the screen horizontally or vertically to switch interfaces

✧ Double tap

Fast double tap on the screen, for example, double tap the screen when video call, will show full screen.

✧ Zoom

In some application, like gallery, you can zoom in and zoom out the picture using two fingers.

4.1.2 Power on/off

4.1.2.1 Power on

The device will power on automatically when plug in the power supply.

4.1.2.2 Power off

You can plug off the power supply if you do use the device, it will help to save the electric power.

4.1.2.3 Restart

Please follow the steps below if you want to restart the device

- 1) Tap "Setting" - "System Maintain"
- 2) Tap "Restart"

4.1.3 Home interface

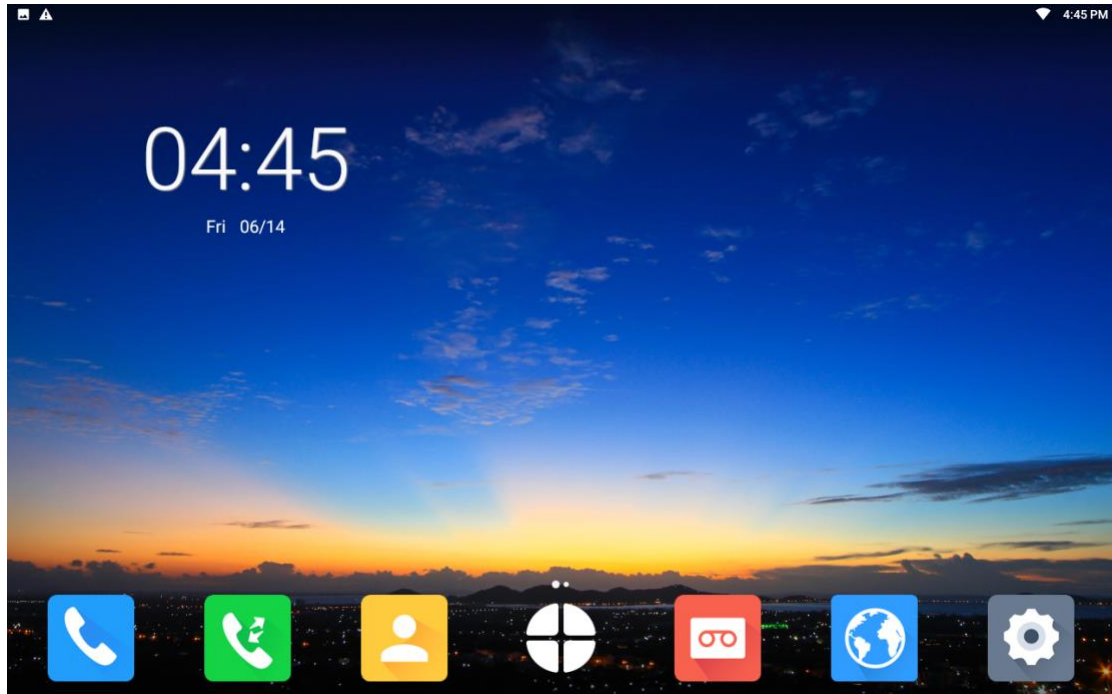

★There are some frequently used applications on bottom of Home interface, there are Dialer, Call Log, Contact List, Record, Browser, Setting

★There is MORE icon on the bottom middle of Home interface, tap to show more applications

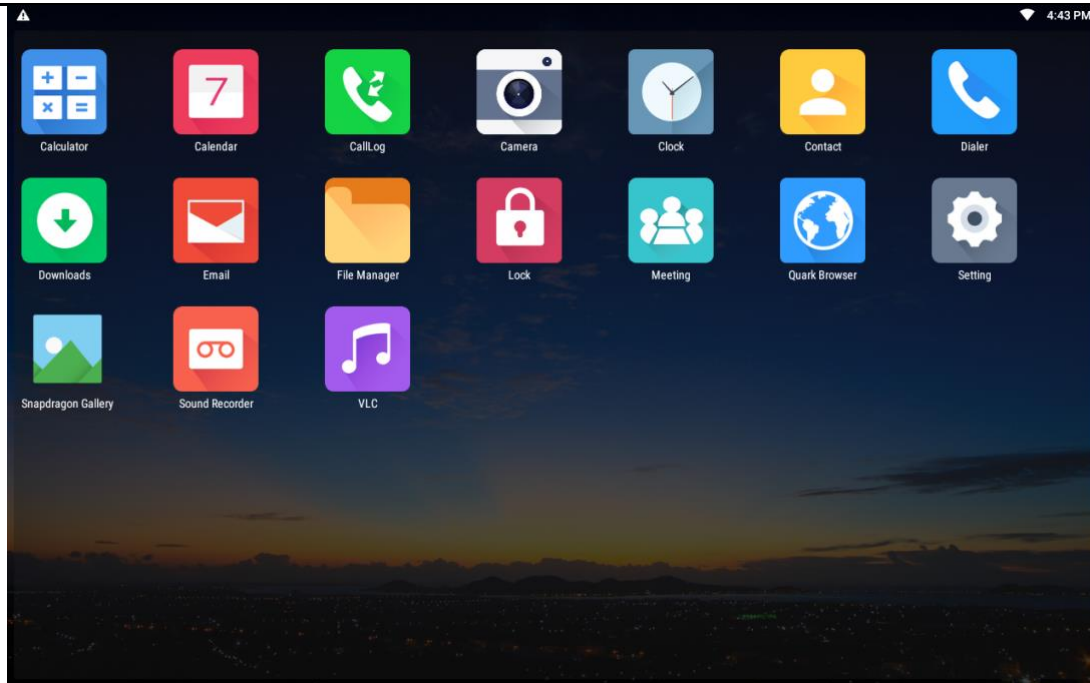

★Date shows on the top left side, SIP account status and network status show on the top right side.

★On the top right side there are showing network status and current account, you can slide down the status bar to switch the accounts.

★Long press to change your wallpaper. Tap wallpaper, and choose the one you want to replace, tap submit on top left side to confirm.

★On home interface, you can slide to speed dial contact interface. Long press someone' s contact on contact list, and create shortcut to this speed dial contact interface. After added, user can tap number or video icon to make audio/video call. Also can delete shortcut by long press.



4.2 Network Setting

This device can support wired network and WIFI. In wired network, it can support both static IP and DHCP. If enable both wired network and WIFI, device will use wired network first.

4.2.1 DHCP

You can configure DHCP following the step as below:

Tap Setting icon—Ethernet, Ethernet is enabled by default, network type is DHCP by default. After select DHCP, it will automatically acquire the IP address from DHCP server. You can check the IP information in Setting—About. Pictures show as below.

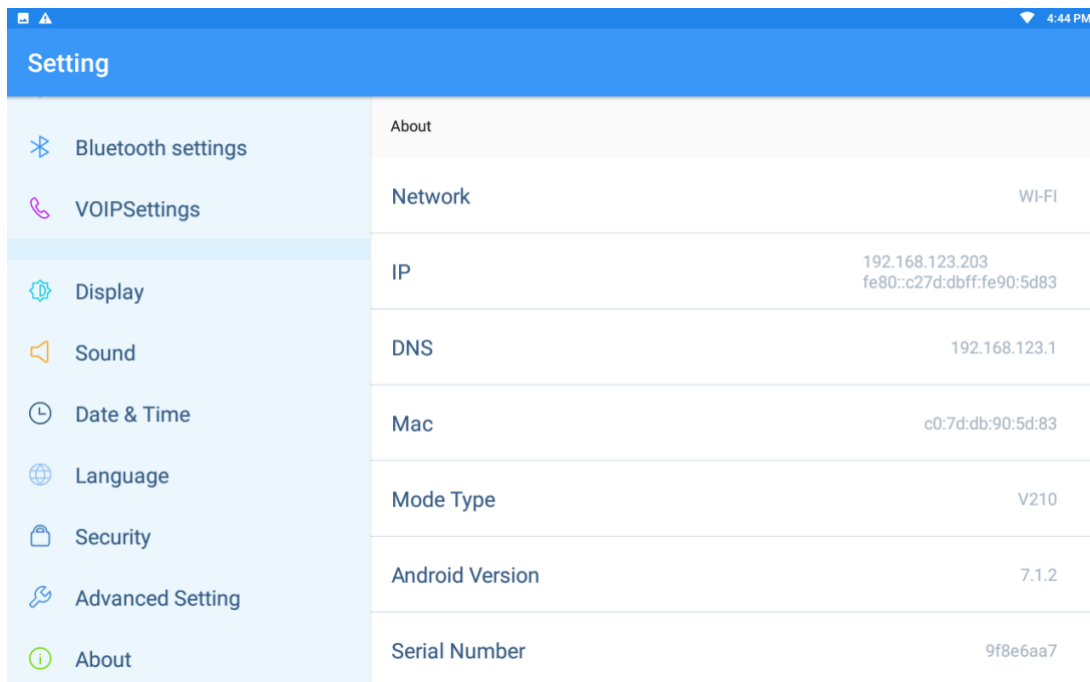
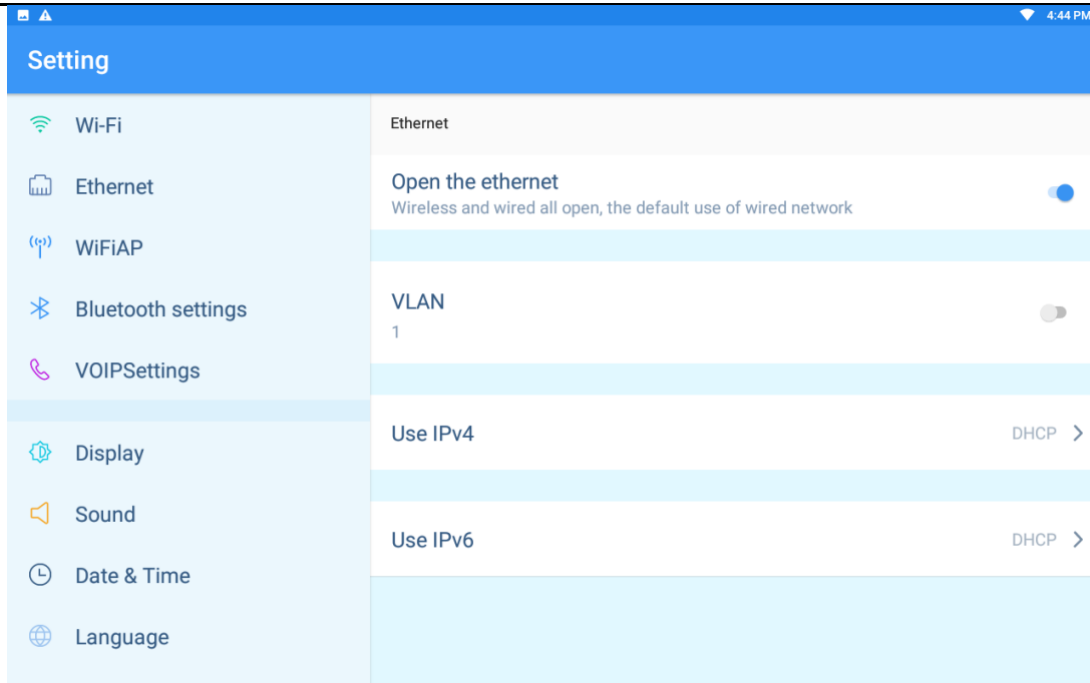

Attention: if fail to get IP address from DHCP, IP address information will show Not Available.

4.2.2 Static IP

You can configure the Static IP following below steps:

Tap Setting icon—Ethernet, select Static IP. Pictures show as below.

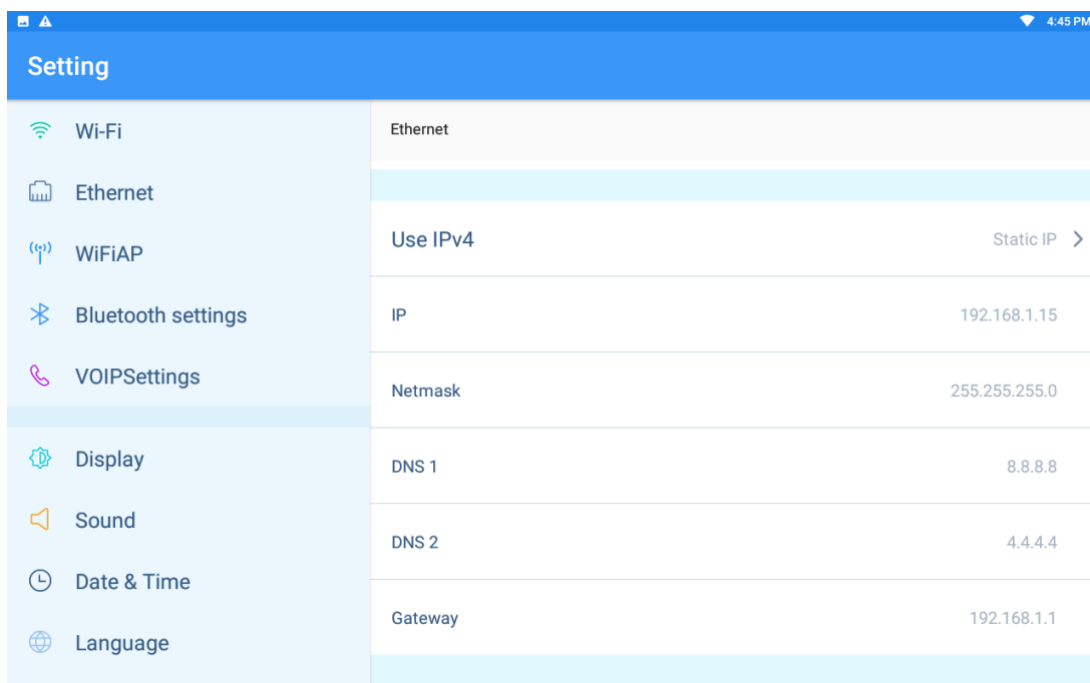
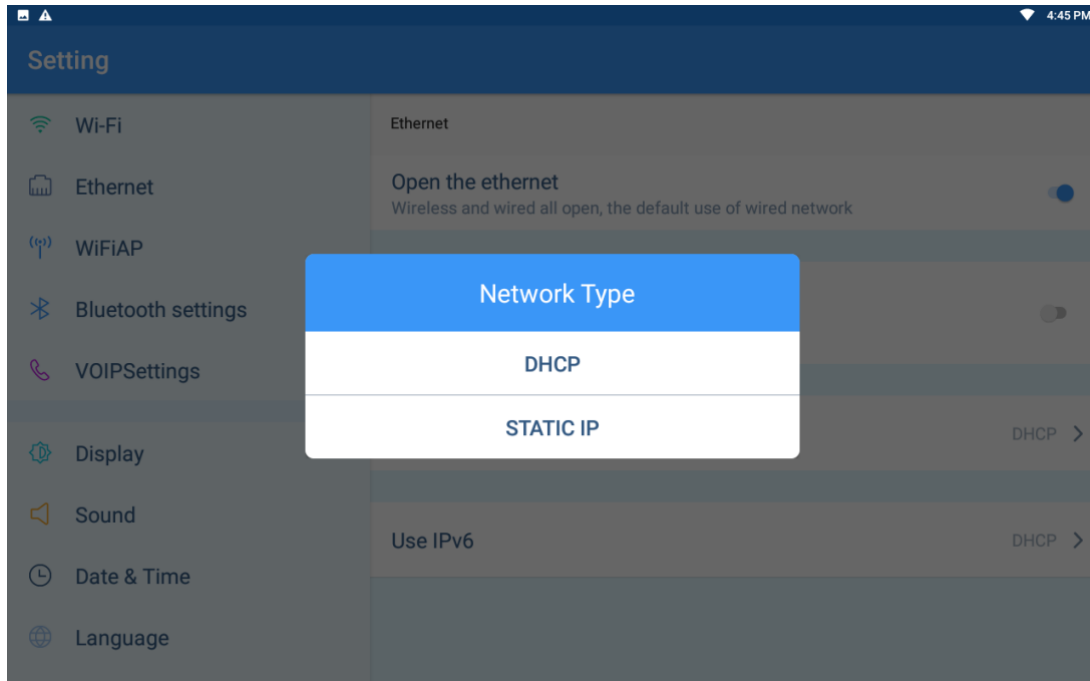

Parameter Description as below

Parameter	Descriptions
IP address	Set the device IP address
Netmask	Set the device netmask
DNS 1	Local main DNS address
DNS 2	Local standby DNS address
Gateway	Set the outbound gateway

4.2.3 Wi-Fi

Tap Setting icon—Wi-Fi, enable Wi-Fi option, and select the WIFI hotspot.

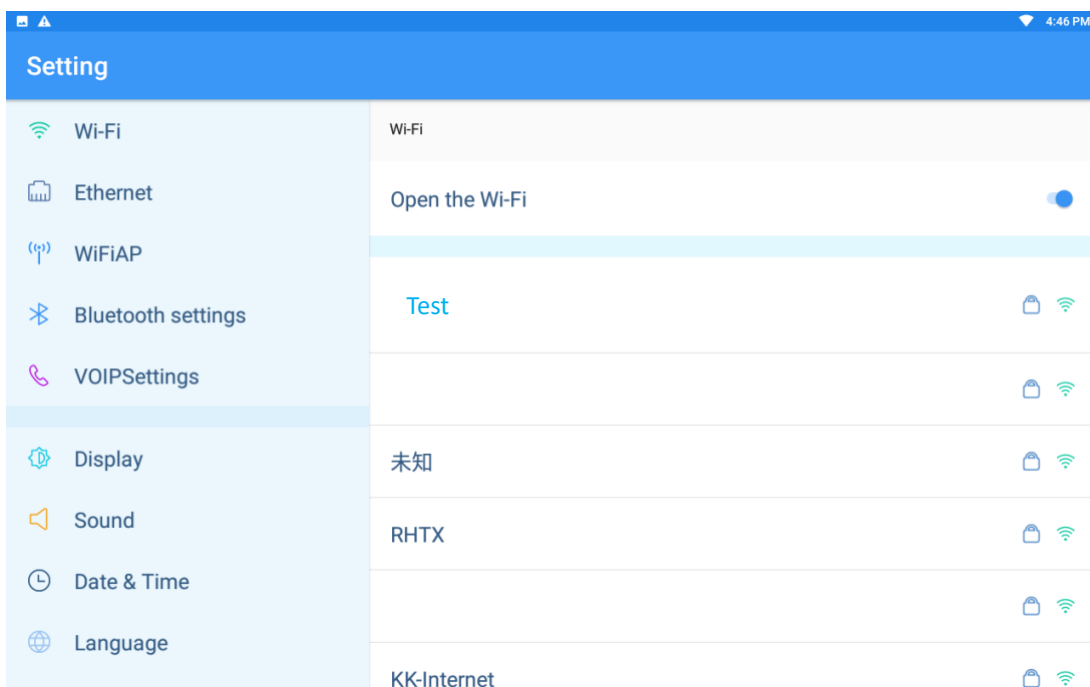

1. After enable the Wi-Fi option, this device will search AP and show on the list.
2. Connect to the available AP. If the AP is with password, it will show a Lock icon next to this AP. If the AP is without password, then won't show the Lock icon.

- When tap the AP with password, please fill in the password to connect. If password error, it will show as below.

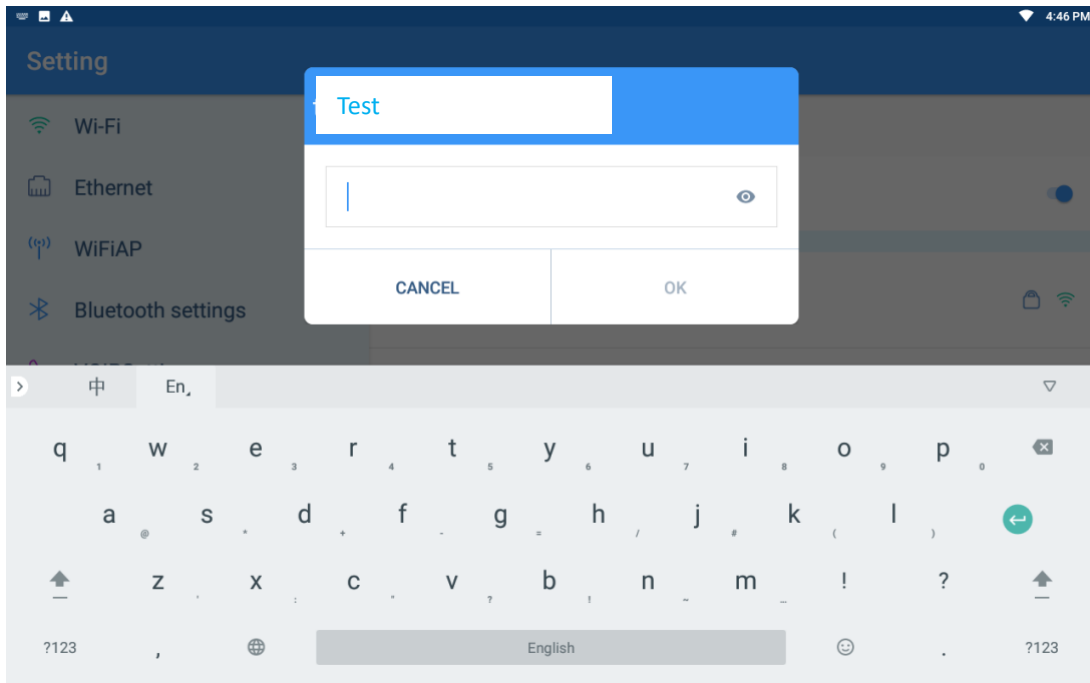

4.2.4 Wi-Fi AP

This device can share hotspot to mobile phones or other wireless devices. Please tap Setting icon—WiFiAP, then can enter to enable the hotspot function.

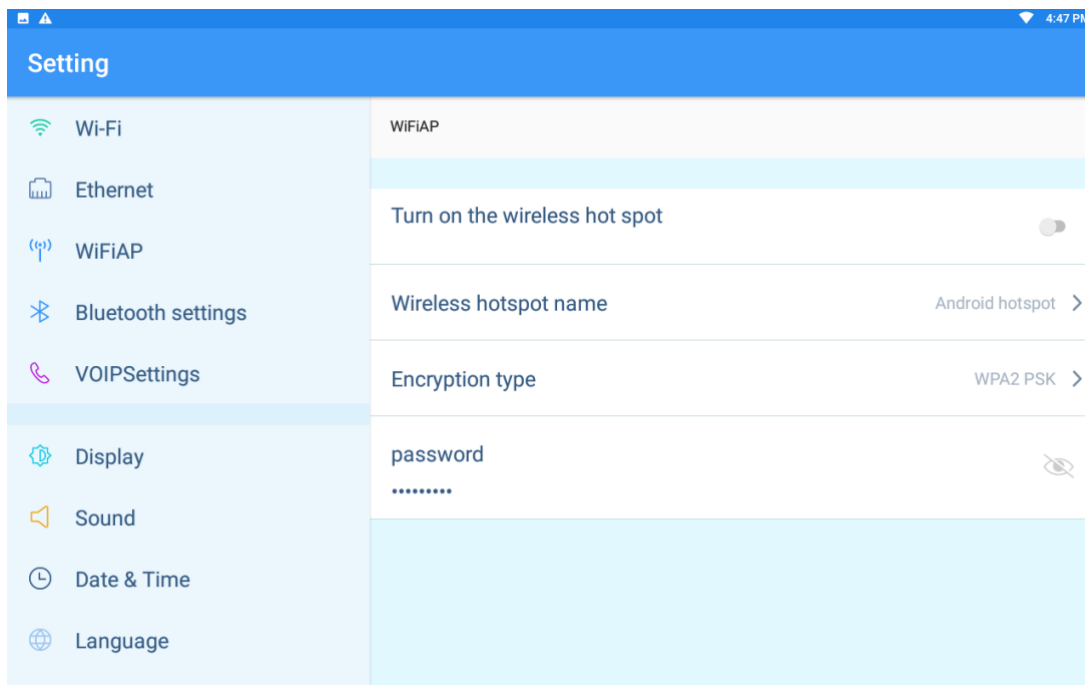

1. First please set the hotspot name and password: Please tap Wireless Hotspot Name, set the hotspot name in the pop-up box. Tap Password, and set the hotspot password in the pop-up box.
2. After finishing the setting of hotspot name and password, you can turn on the wireless hotspot, then can be searched by the mobile devices.
3. Encryption Type: the encryption type is WPA2 PSK. If you select NO in Encryption type, then no need hotspot password for mobile devices connecting.

4. Attention: When the device Wi-Fi connecting, the hotspot cannot work at the same time. When enable the hotspot, please ensure the Ethernet wire connecting with the device, and ensure the

4.3 VOIP Setting

VoIP Settings are including SIP Account Setting and Call Setting.

You can enter VoIP setting interface using these two methods:

Method 1: Tap Setting icon—VOIP Settings

Method 2: Tap Dialer App—Tap setting icon on top right side—Tap Call Setting

4.3.1 SIP Account Setting

After enter VoIP setting, please tap Account Setting, and then enter the SIP account setting interface.

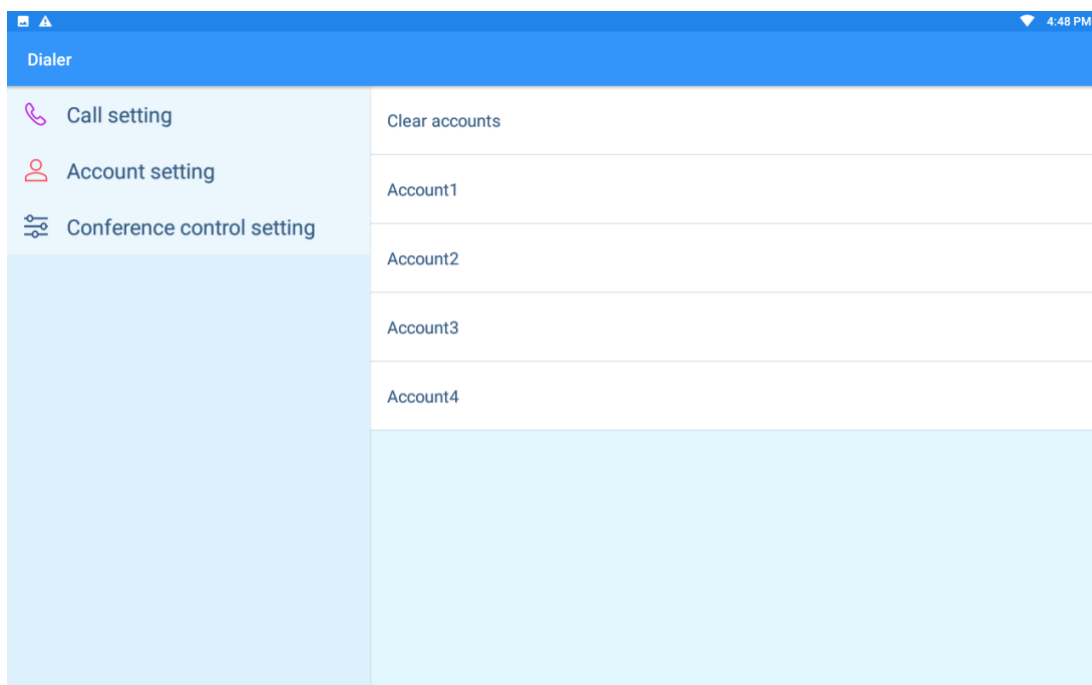

There are 4 VoIP accounts available to set, please tap one of them to enter the configuration interface.

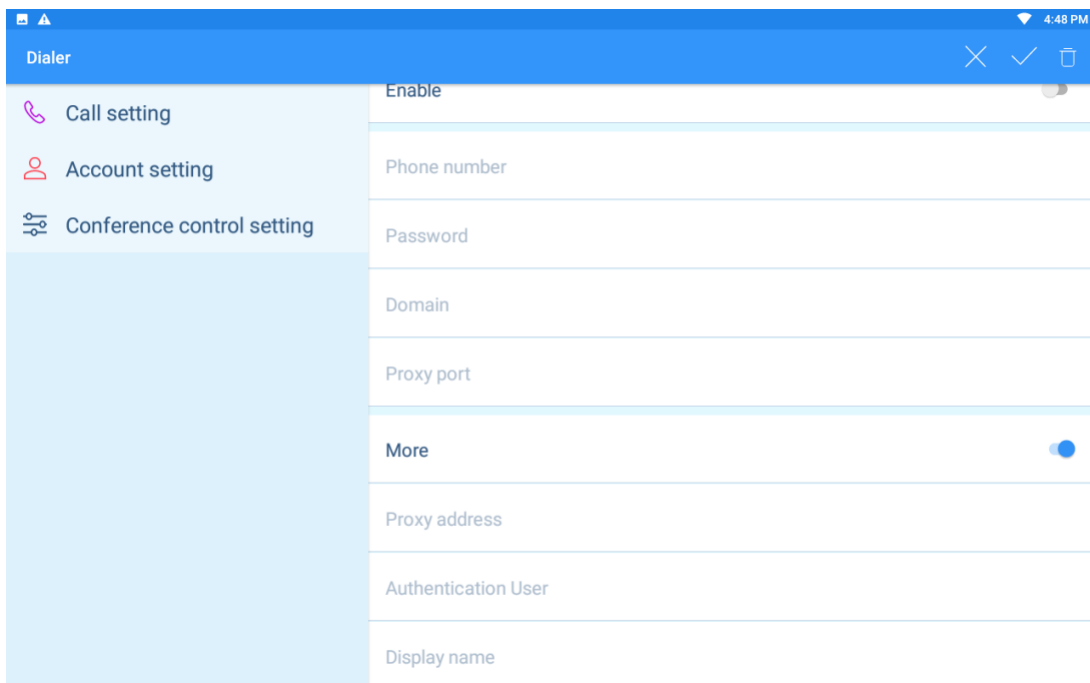
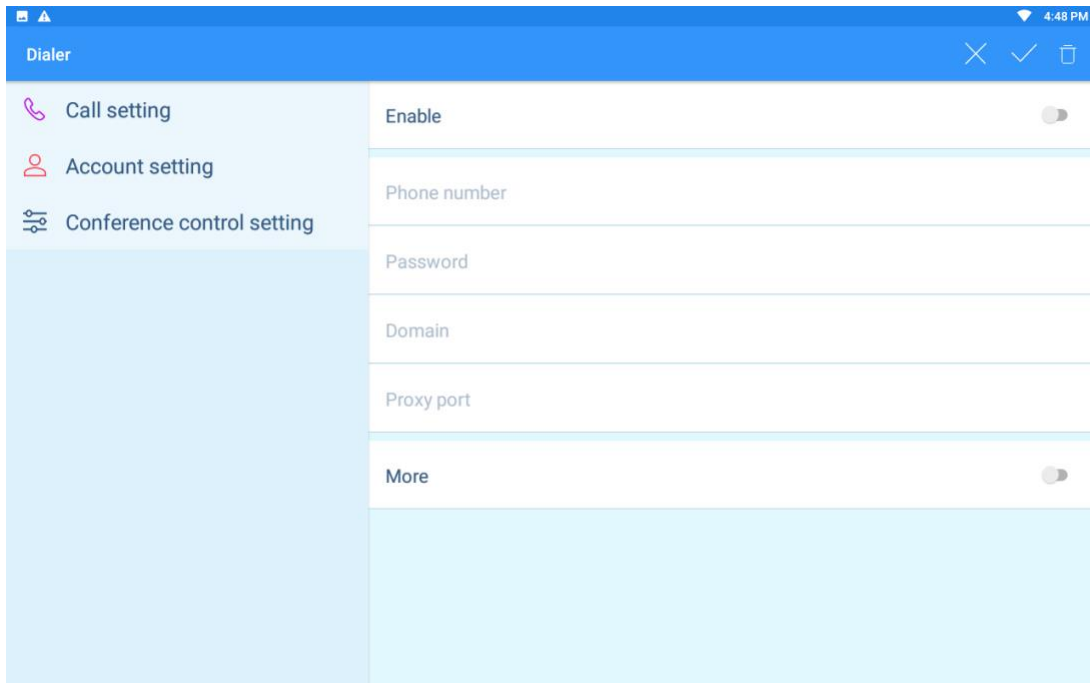

Parameter description as below:

Parameter	Descriptions
Enable	Enable the VoIP account
Phone number	The register ID of SIP account
Password	The register password of SIP account
Domain	The register server of SIP account, server configuration format should be domain/IP[:port],server could be domain or IP address
Proxy port	The register server port of SIP account, 5060 by default if not fill in
More	<ol style="list-style-type: none"> 1. If the account and name are same, and the domain and the proxy port are same, you not set More, device will auto fill in the More. 2. If the account and name are different, or the domain and the proxy port are different, then please tap More to manually set.
Conference control setting	This option is for Huawei Video Conference, if not connect with Huawei Video Conference, then no need to configure.
Proxy address	The main proxy server, server configuration format should be domain/IP[:port], server should be domain or IP address
Authentication User	SIP authentication user name
Display name	The register account display name, optional to fill

Please tap  to submit the configuration, then success to set the SIP account.

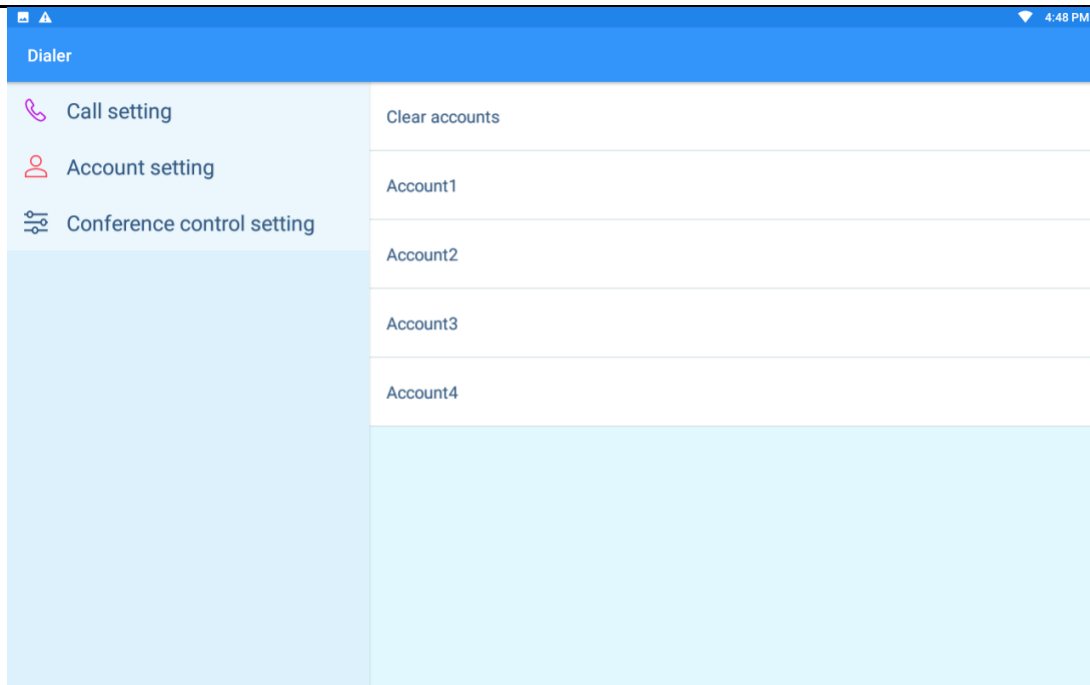

If want to modify the account setting, please tap the account directly, and set it basing on your need. Please tap ✓ to submit after configuration. Clear accounts option to clear all account configurations.

4.3.2 Call Setting

After enter VoIP setting, please tap Call Setting to configure the call, picture show as below:

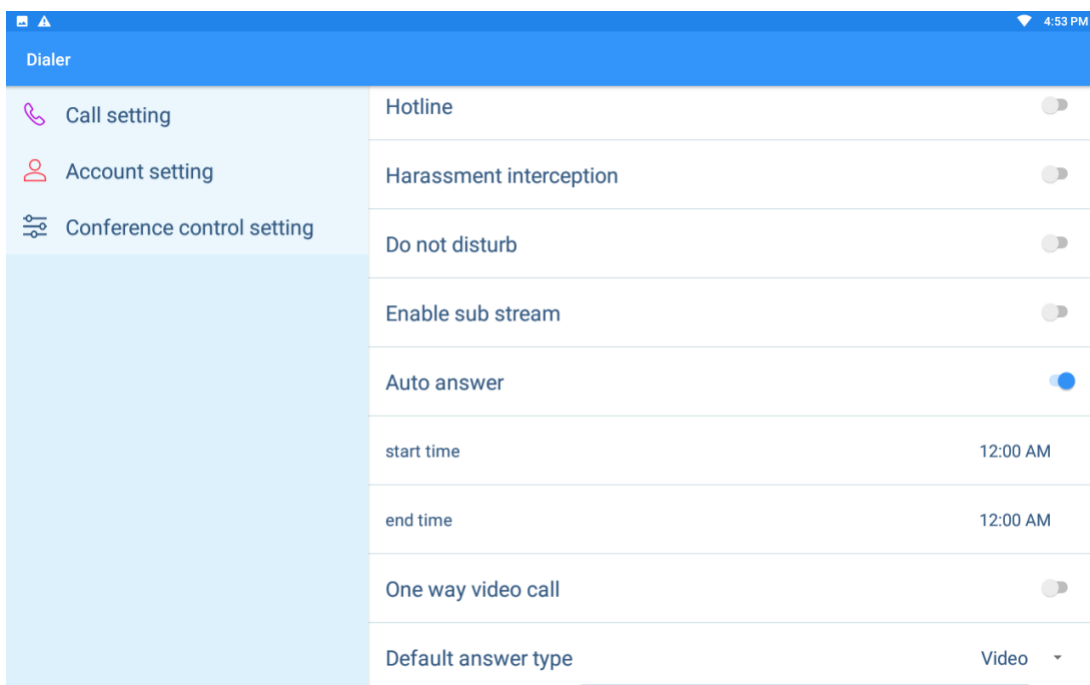
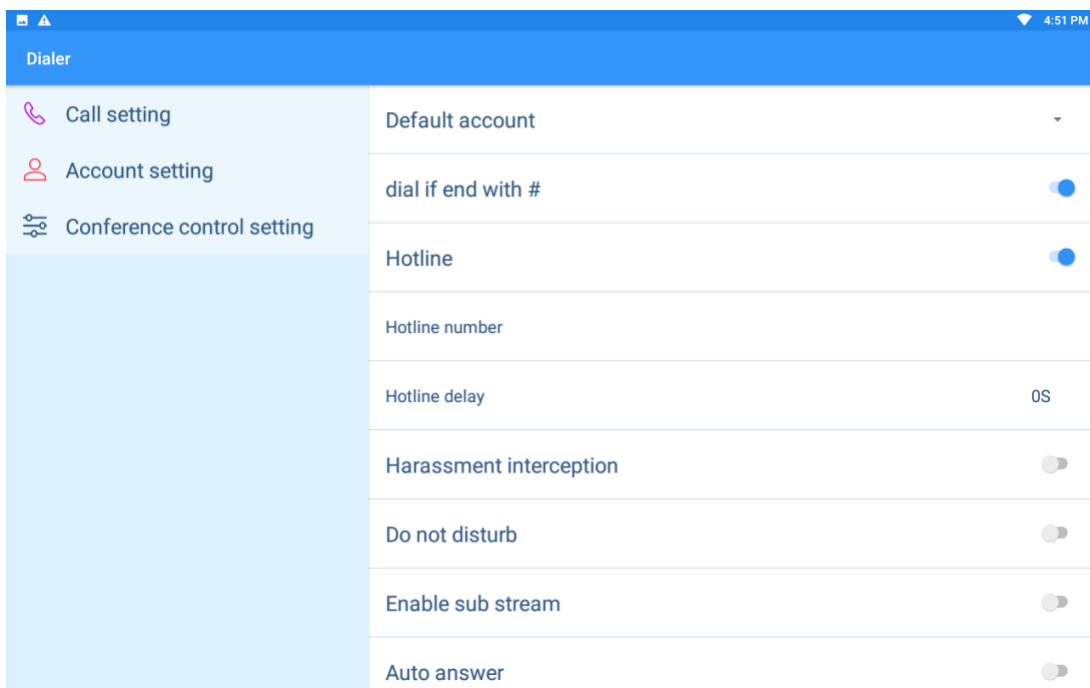

4.3.2.1 Dial if end with

After enabling this option Dial if end with #, when dialing, press # to call out after press all number. This option is enabled by default.

4.3.2.2 Hotline

After enable Hotline, can set the Hotline number and Hotline delay time, the hotline delay time is 0 by default.

After enable and set the hotline, when user off hook, if not dial any number, the device will call out automatically after Hotline delay time.

The Hotline function is disabled by default.

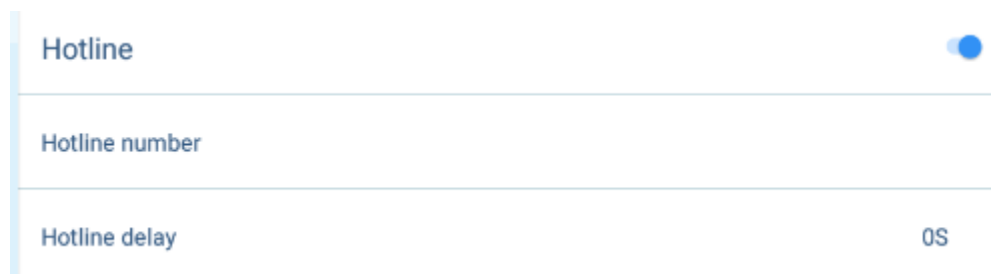

4.3.2.3 Harassment Interception

Harassment interception is the black/whitelist function. Tap to enable Harassment Interception, it is Only Block Blacklist mode by default in interception rules. Can tap Harassment interception for more configurations, as below picture.

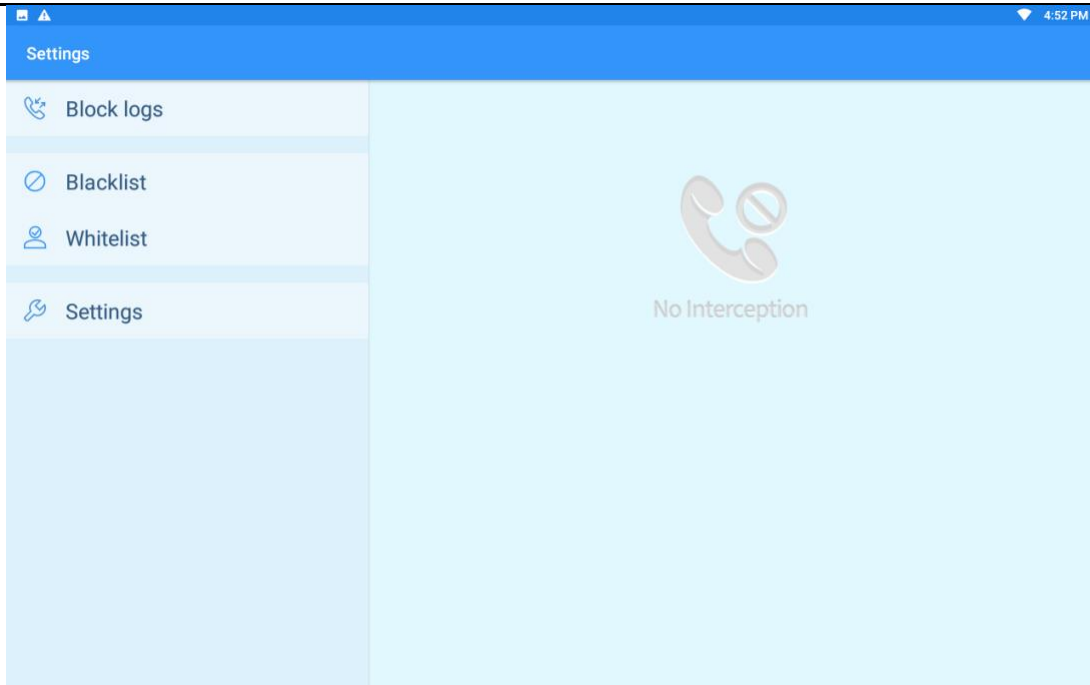

Block logs: can check the block logs. The missed block logs will show on message bar, drop down the message bar to check the missed block logs, as below:

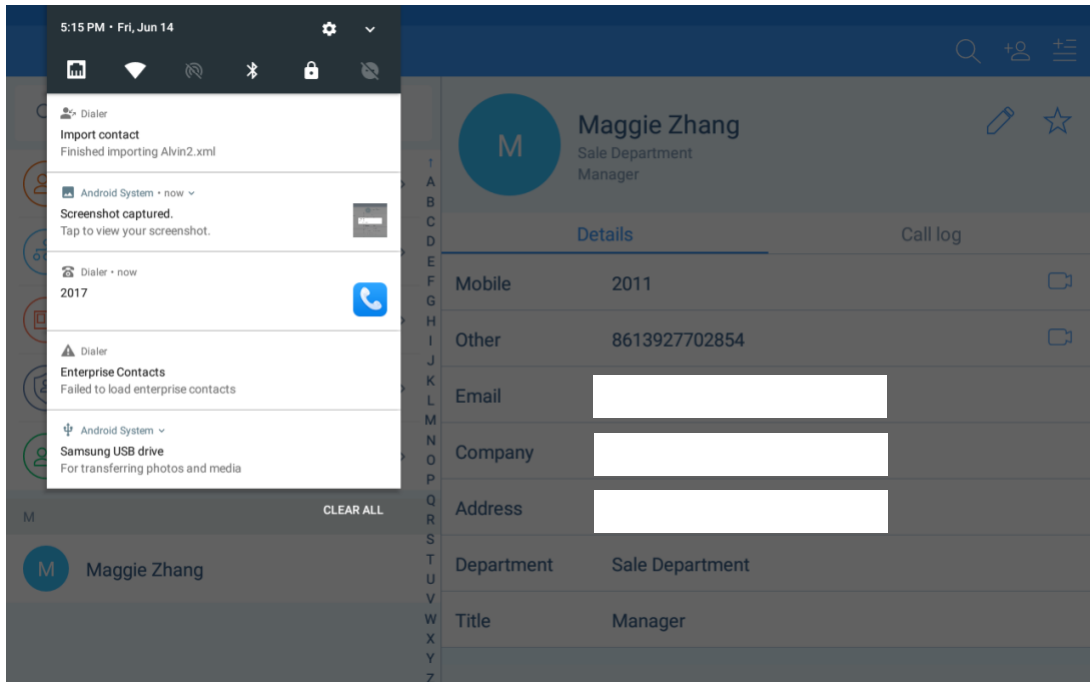

Blacklist: can add/modify/delete the black list. The method to add/modify/delete are as below:

1. Long press the contacts log or contact number, select to set as black list.

2. Enter Setting—VOIP Settings—Call setting—Harassment interception—Blacklist, tap Add to fill in number, name(optional) to set blacklist. Tap the number in Blacklist to modify. Long press the number to delete.

Whitelist: can add/modify/delete the blacklist. The method to add/modify/delete are as below:

1. Long press the contacts log or contact number, select to set as white list.
2. Enter Setting—VOIP Settings—Call setting—Harassment interception—whitelist, tap Add to fill in number, name(optional). Tap the number in Whitelist to modify. Long press the number to delete.

Interception settings:

1. Enable the Intercept service to enable Blacklist or Whitelist.
2. The interception rules have Only Block Blacklist, Only Answer Whitelist. User can select it basing on need.
3. Enable Blacklist Enable Time, to active the intercept service. Picture shows as below.

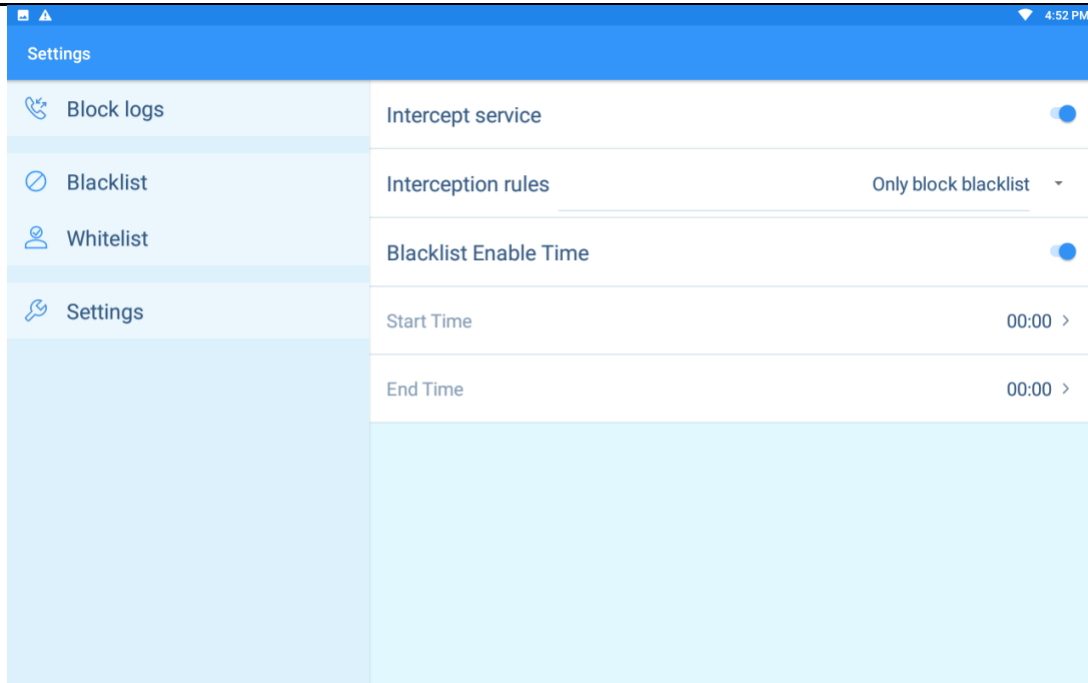

4.3.2.4 Do Not Disturb

Enable Do Not Disturb option to reject all calls. This option is disabled by default.

4.3.2.5 Enable Sub Stream

This option is enabled by default.

After enabling it, device can send sub stream to opposite end terminal by accessory, like HDMI, Wi-Fi screen sharing. This device can accept the sub stream from opposite end terminal. After disabling this option, device cannot get or send any sub stream.

Attentions: If the server don' t support sub stream, please disable sub stream before video call.

4.3.2.6 Auto Answer

After enabling this Auto Answer option, device can pick up all incoming calls during from start time to end time. It will be cyclically effective. s

Auto answer	<input checked="" type="checkbox"/>
start time	12:00 AM
end time	12:00 AM

4.3.2.7 One Way Video Call

This option is disabled by default. After enabling this option, device will do video decoding but don't do video coding, that means during video call, local end will see the video view, but the opposite end cannot see the video view.

4.3.2.8 Default Answer Call

Default Answer Call in one setting of auto answer, can select video or audio. Video by default. When select video, when incoming call, it will be video call priority. If the opposite end is audio call, then will turn to auto audio call.

When select Audio, no matter audio incoming call or video incoming call, the local end will pick up call using audio mode.

4.3.2.9 Show Video Parameters

Show video parameters during video call. After enabling it, it will show icon 

during video call. Tap this icon to show both ends parameters, including video codec, video resolution, video bitrate, video frame rate, etc.

4.3.2.10 IP Address Dial

After enabling this option, allow to dial to IP address. Enable by default.

4.3.2.11 Echo Cancellation Level

It means to cancel the device echo from MIC collection, to delete the effect of device sound card drift.

There are four options, None, Low, Medium, High. Select None to disable Echo Cancellation Level. When select Low/Medium/High, will enable echo cancellation and noise suppression both.

Noise Suppression means when there is any noise device collected, will cancel the noise for users.

Attentions: the level higher, the more serious the voice damage. High level will cause sound distortion.

4.4 Bluetooth Settings

Tap Setting icon—Bluetooth settings to enter Bluetooth interface, show as below:

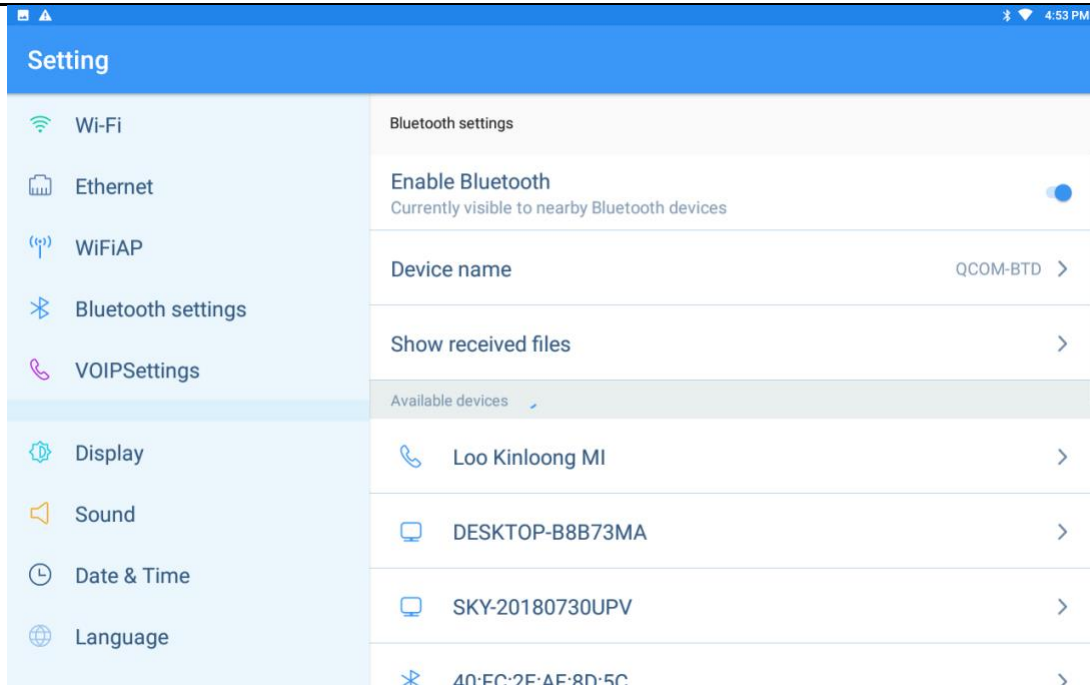

Enable Bluetooth:

1. After enable Bluetooth, the device will search Bluetooth device and show all on list.
Tap the Bluetooth to connect. After successfully pair, will show on Available Devices list.
2. After enable Bluetooth, other devices can search and connect with this device with you allow.

Device name: tap to set the device Bluetooth name.

Show received files: Tap to check the files sent from other devices by Bluetooth.

4.5 Display Setting

Tap Setting icon—Display, to configure the display parameters.

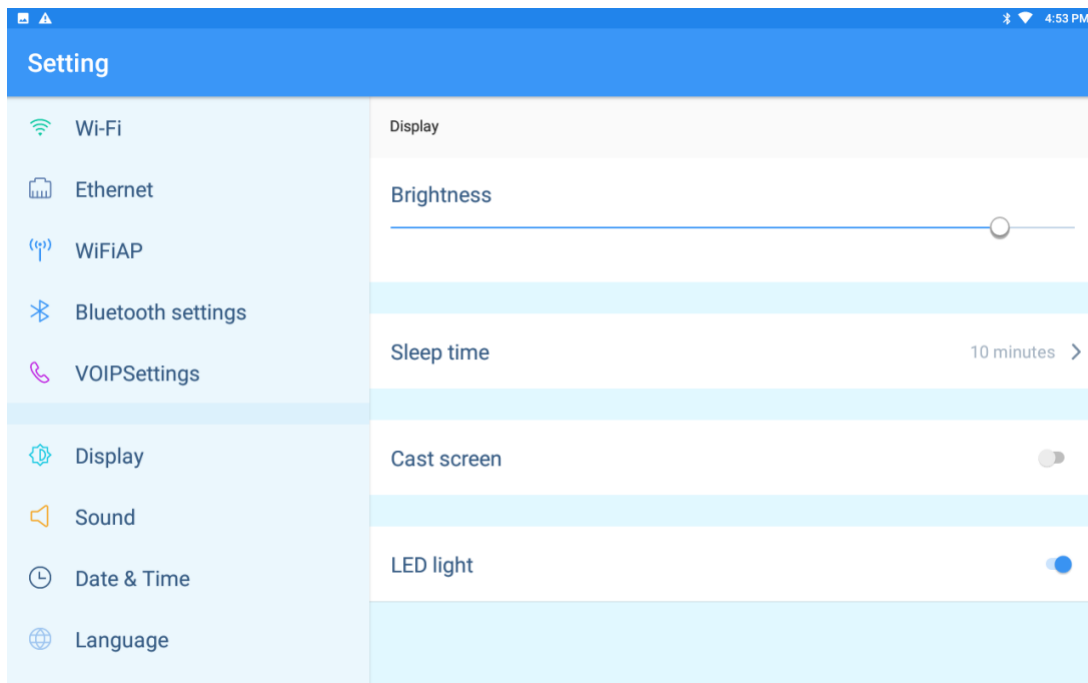

- ✧ **Brightness:** Configure the brightness of the screen, can drag progress bar or tap the brightness level.
- ✧ **Sleep time:** set sleep time. Device will shut down the screen once over the sleep time.
- ✧ **Cast screen:** Wireless screen sharing, device can share screen by Wi-Fi.
- ✧ **LED light:** Enable LED light, when making call or ringing, LED light will light on or twinkle for different status. If disable the LED light, it will keep light off no matter which status.

4.6 Sound

Tap Setting icon—Sound to enter voice setting interface, picture show as below.

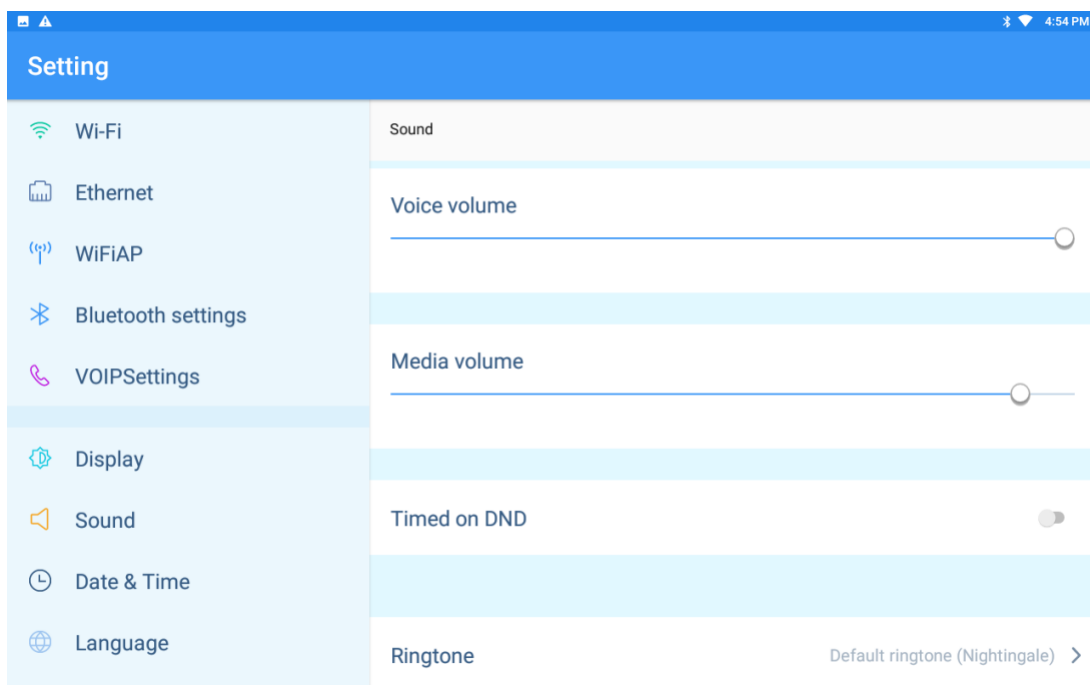
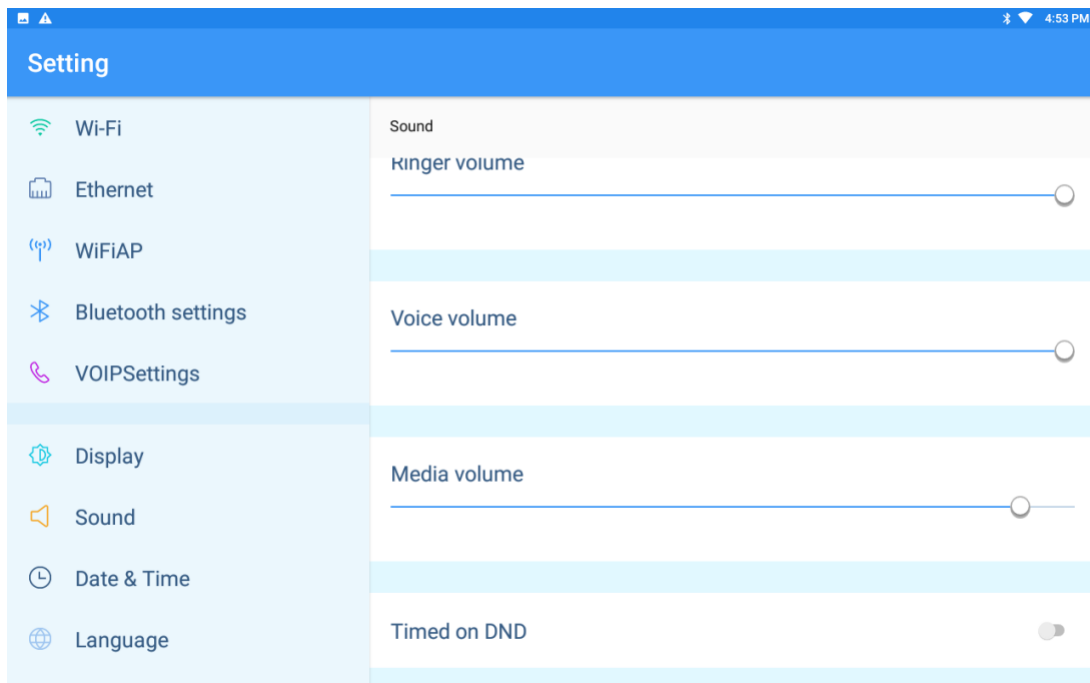

- ✧ Ringer Volume: User can drag the bar to set ringer volume, or tap somewhere on bar to set a ringer volume.

- ✧ Voice Volume: User can drag the bar to set voice volume, or tap somewhere on bar to set a voice volume.
- ✧ Media Volume: User can drag the bar to set media volume, or tap somewhere on bar to set a media volume.
- ✧ Timed on DND: After enabling this function, when incoming call, will show the incoming call screen but no ring. Can set the DND start time and end time, and repeat it. Picture shows as below:

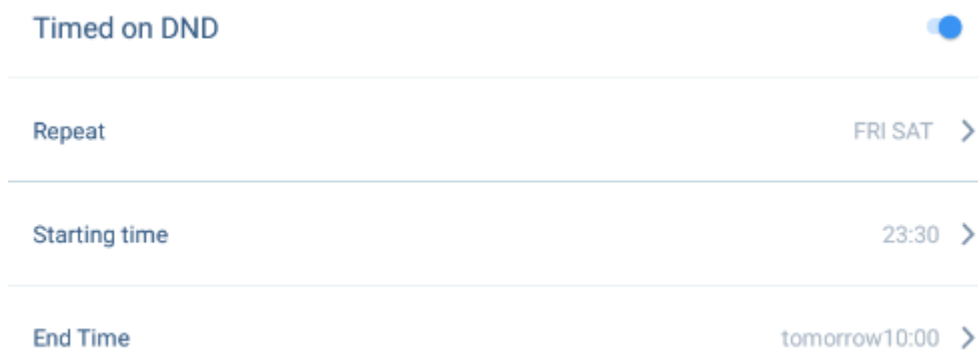

- ✧ Keyboard tone: Enable by default. When keyboard filling in, it will have tone.
- ✧ Incoming ringtone: Tap Default ringtone to select a ringtone, can select system ringtone or custom ringtone. Tap ✓ to submit.

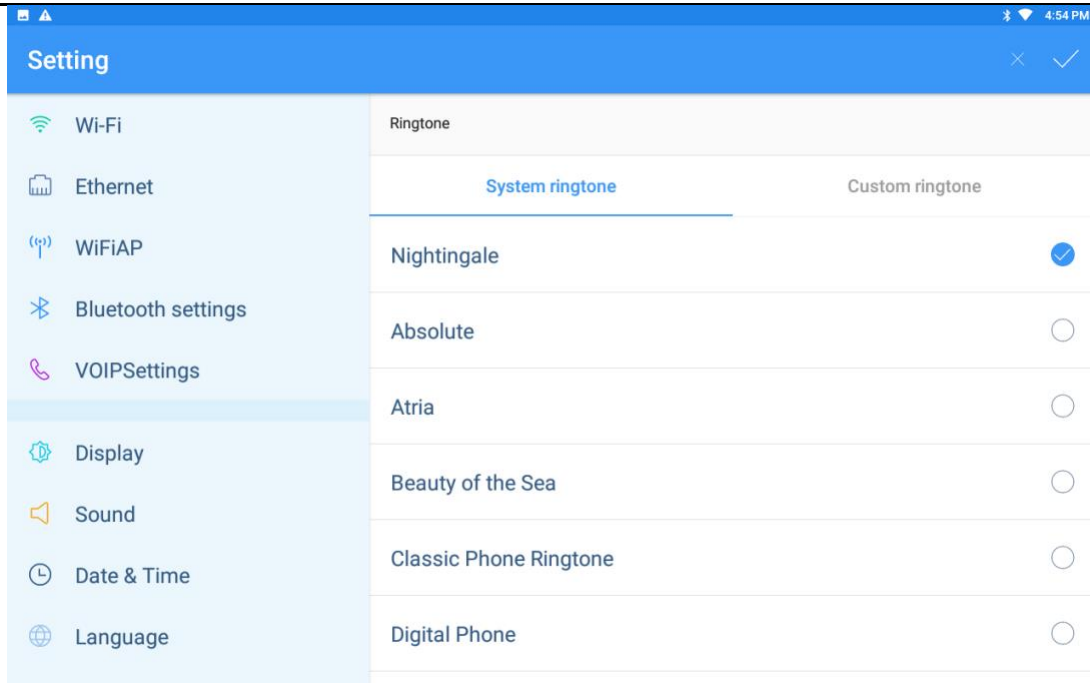

4.7 Date & Time

Tap Setting icon—Date & Time, to enter the date configuration interface, picture shows as below:

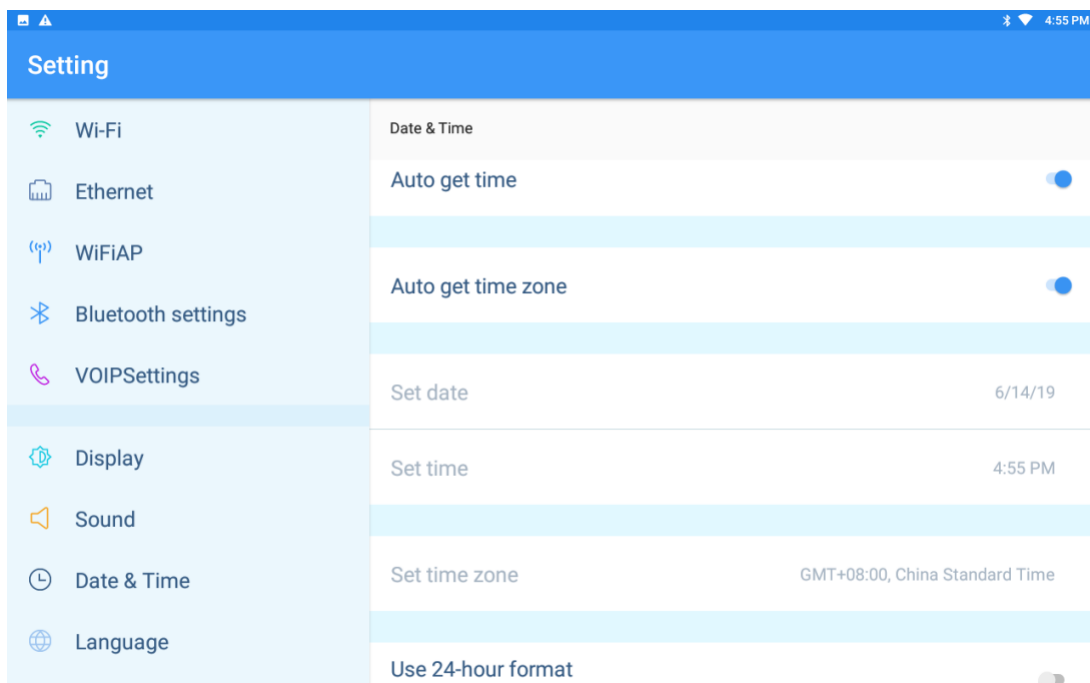

1. Device is Auto Get Time by default. Auto get time zone, is the date and time same

with device networking server.

2. If want to set by manual, can disable Auto Get Time and Auto Get Time Zone, then set date and time manually.
3. Use 24-hour format: Enable this option to set hour format. If disable this option, device time formation will be 12-hour format.

4.8 Language

Tap Setting—Language to enter language interface. Language options are including English, Simplified Chinese, traditional Chinese.

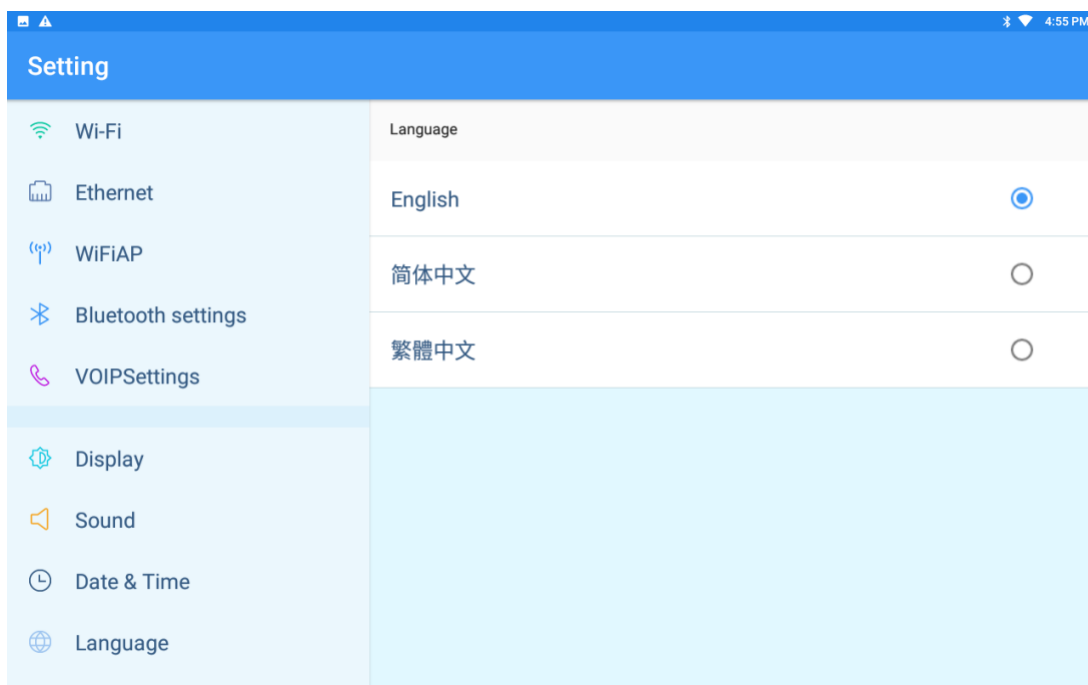

4.9 Security

Tap Setting—Security, to enter security configuration interface, can set screen lock.

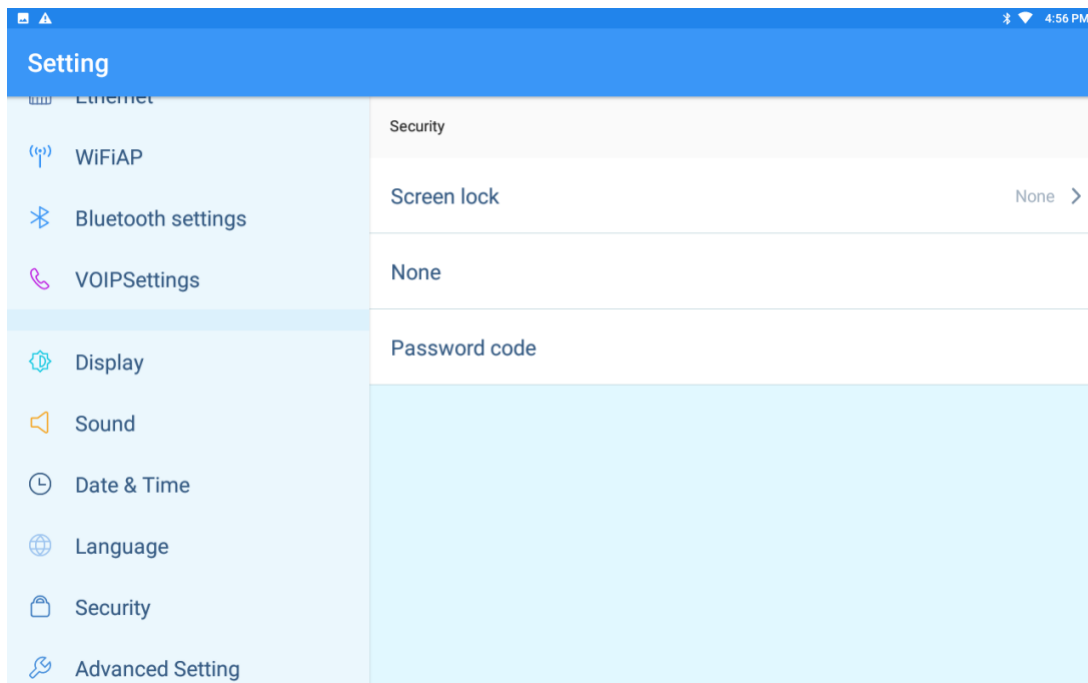

- ✧ None: None by default will enter device interface without any password.
- ✧ Slide to enter: Slide up to enter device interface.
- ✧ Password: fill in password to enter device interface.

4.10 Advanced Setting

Tap Setting icon—Advanced Setting, to enter the system maintenance.

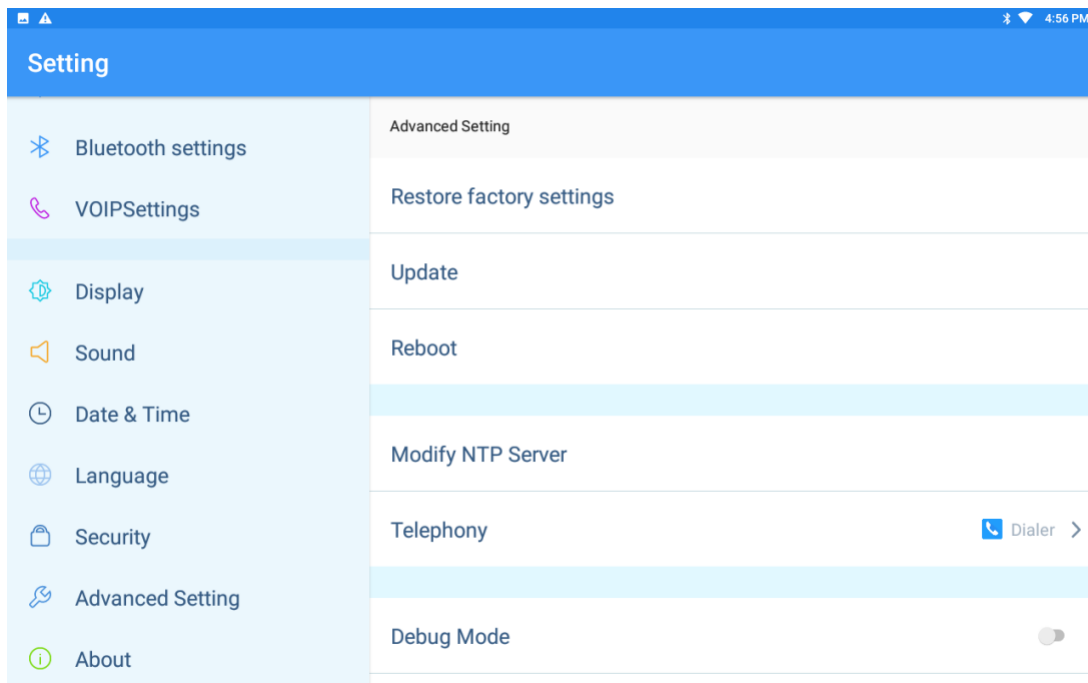

- ✧ Restore factory settings: After Restore factory setting, all settings and information will be cleared. Setting steps: Tap Restore factory settings—OK—Factory data reset—reset phone—Erase everything
- ✧ Update: Use disk to copy update.zip file on system root directory, and tap update to upgrade the system.
- ✧ Reboot: Tap reboot to reboot the device.
- ✧ Modify NTP server: NTP server is clock source. User can set the NTP server basing on real need.
- ✧ Debug mode: special for developer to debug device, if you are not the developer, please do not enable this option.

4.11 About

Tap Setting icon—About, to enter system information interface. You can get network information like IP/DNS/MAC, model, Android version, SN, firmware version, hardware version in this interface.

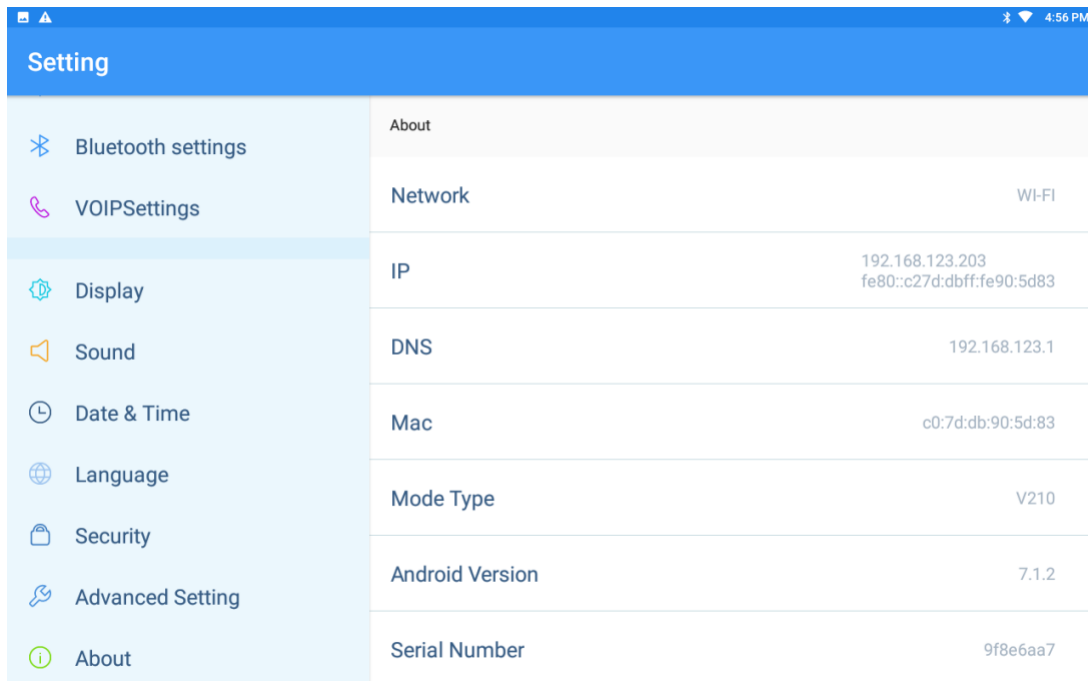

5 How to use

5.1 Call function

The phone support audio call and video call. When using call function, please make sure available SIP accounts are already configured. Please refer to 4.1 for the configuration of SIP accounts.

5.1.1 Dial numbers

You can dial numbers with the dialer, with the contacts, or with the call records.

5.1.1.1 Dial directly



Below are measures to enter the dialer interface

- ★ Pick up phone directly, it means pick up the handset.
- ★ Press the hand-free button.
- ★ Click the dialer icon  on the main screen of phone.

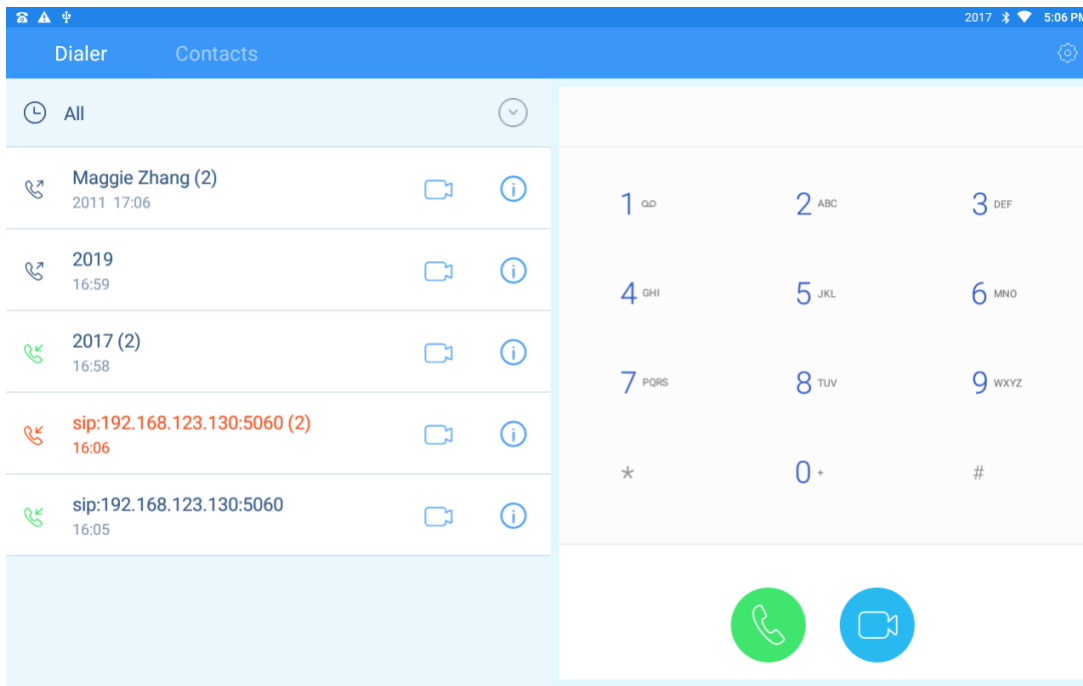
The dialer interface is as below.



1. Press the digit buttons to dial the numbers, press  key to delete certain number.

2. After inputting numbers, click  to start audio call, click  to start video call.

If enabling "Dial if end with #" , then once dial numbers and press #, it will immediately start an audio call.

3. After registering multiple available SIP accounts, we can select the wanted account with the dropdown on the right side on any screen.



5.1.1.2 Dial from Contacts

We can enter the contact screen in below ways.

- ★ Enter the dial screen, and click the “Contacts” label.
- ★ Tap the “Contacts” icon  on main screen.

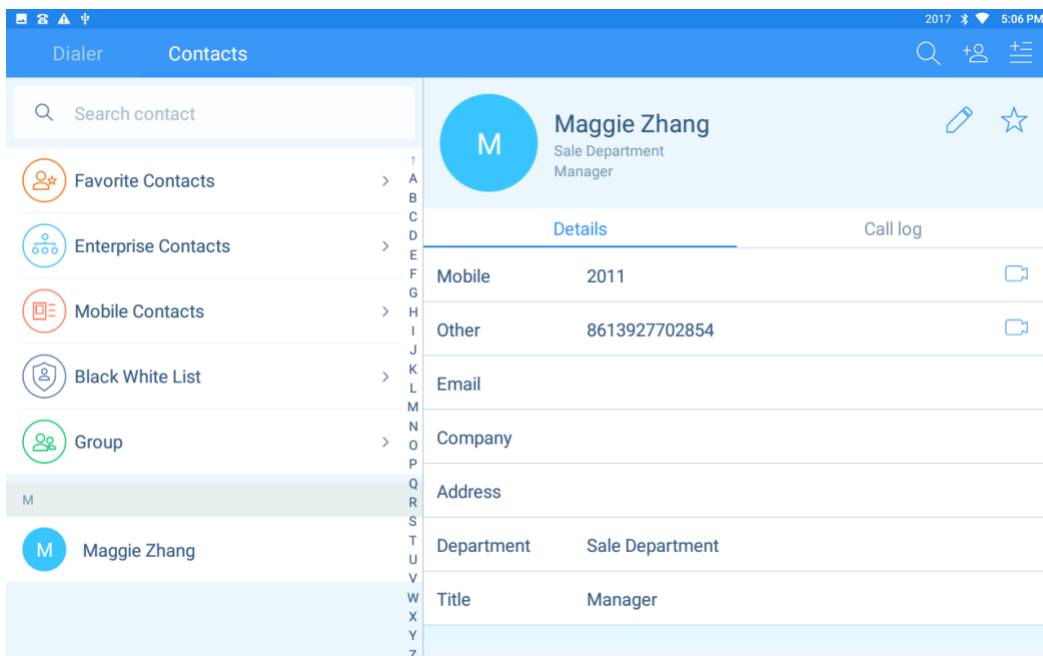

The Contacts includes "Favorite Contacts" , "Enterprise Contacts" , "Mobile Contacts "and "Group" .

Through clicking any contact, or inputting the first letter, name, numbers, the details of contact will be displayed on the right side. Click the numbers, we can make audio calls. Click the  icon, we can make video calls. We also can long click the numbers, to invoke function of "Edit before call" , then we can add prefix or re-edit the numbers to dial out.

5.1.2 Incoming calls

When there is an incoming call, the phone rings and the screen display the incoming call information.

1. If it is a call from stranger, the call screen displays the phone number and the place where the call number belongs;
2. If the caller is in our contacts, the number, name and number Calero will be displayed;
3. If the caller is the contact person in "Enterprise Contacts" , the number, name, department and Calero will be displayed.

5.1.2.1 To answer the audio call

When we receive an incoming audio call, it' s like this picture.

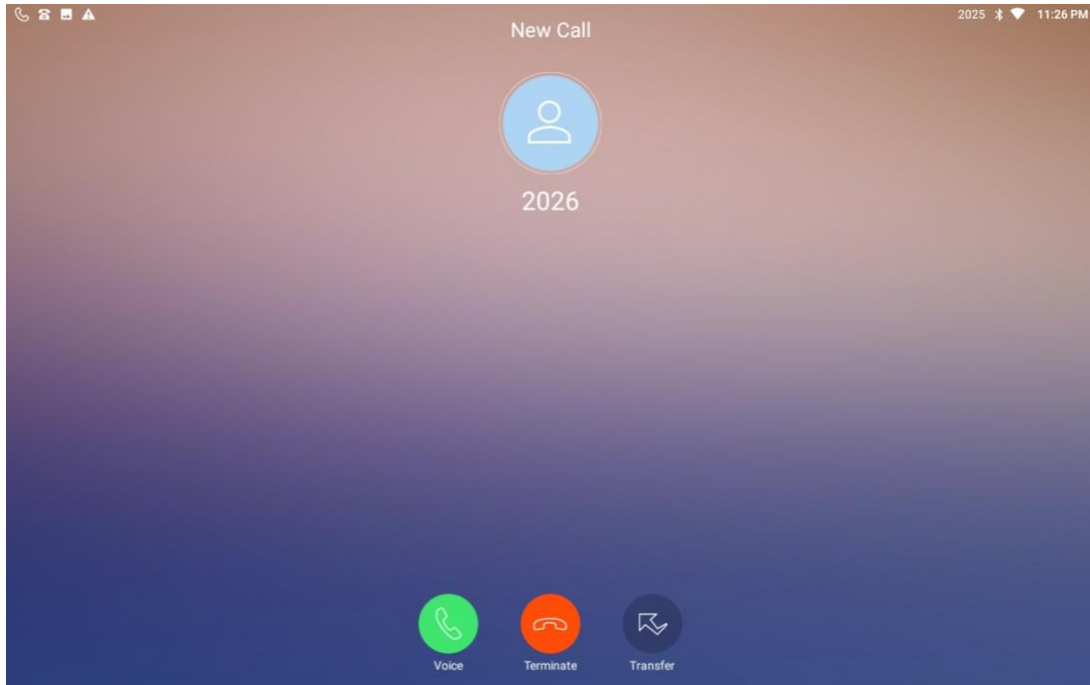



We can click the audio receiving button  to answer the call, or pick up the handset, or press Handfree button to answer it.

5.1.2.2 To answer the video call

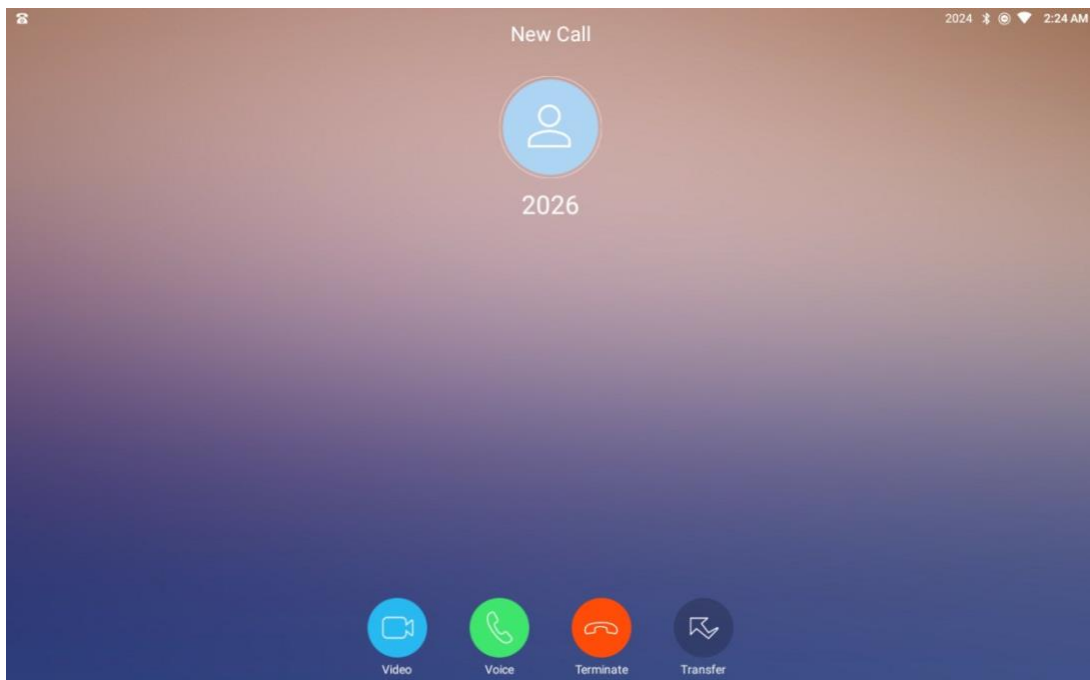
When we receive an incoming video call, it' s like this.



We can click the  button to answer the video phone call, if we click the  button, or simply pick up the handset, or press Handfree button, then it will be an audio call.

5.1.2.3 Reject an incoming call

No matter the incoming call is an audio or a video call, we can reject with a click of  button.

5.1.2.3 Call Transfer

Call Forwarding means to forward the incoming call to a certain number which is input by user.

When the device receives a call, click the "Transfer" button, and enter the number before next pop-up interface (as shown in the figure below). Click to complete the call transfer.

Example: extension 2026 call 2025, user 2025 click "Transfer" on the incoming call popup screen, enter 2011 in the popup interface and click.

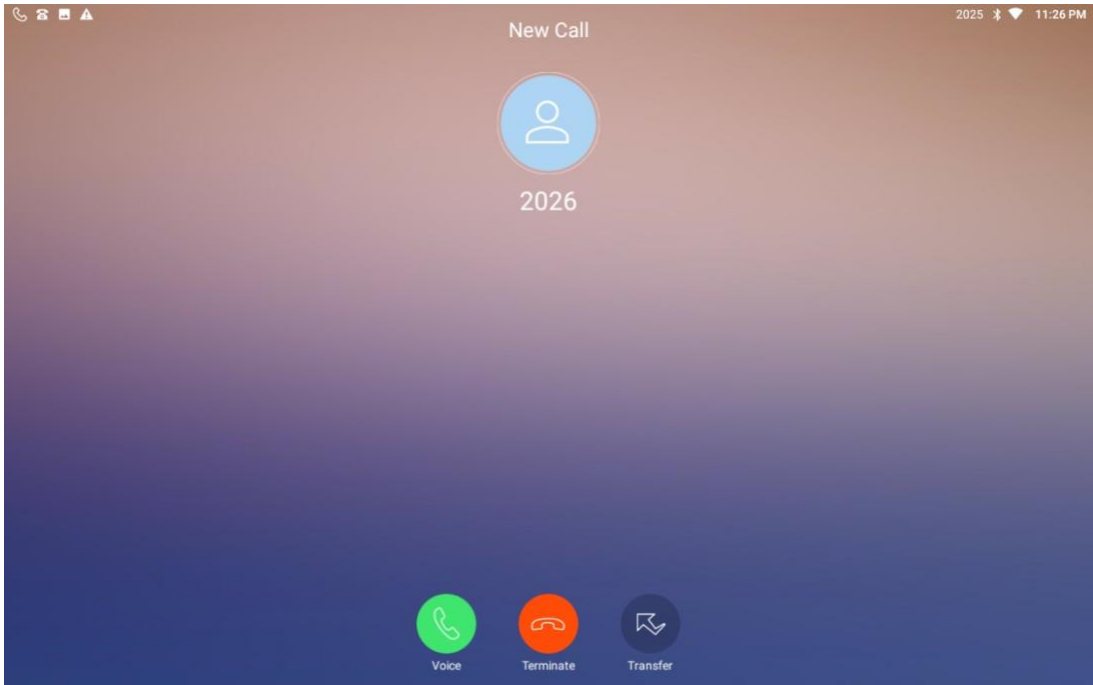

This equipment 2025 stop ringing, 2011 ring and answer, 2011 and 2026 talk.

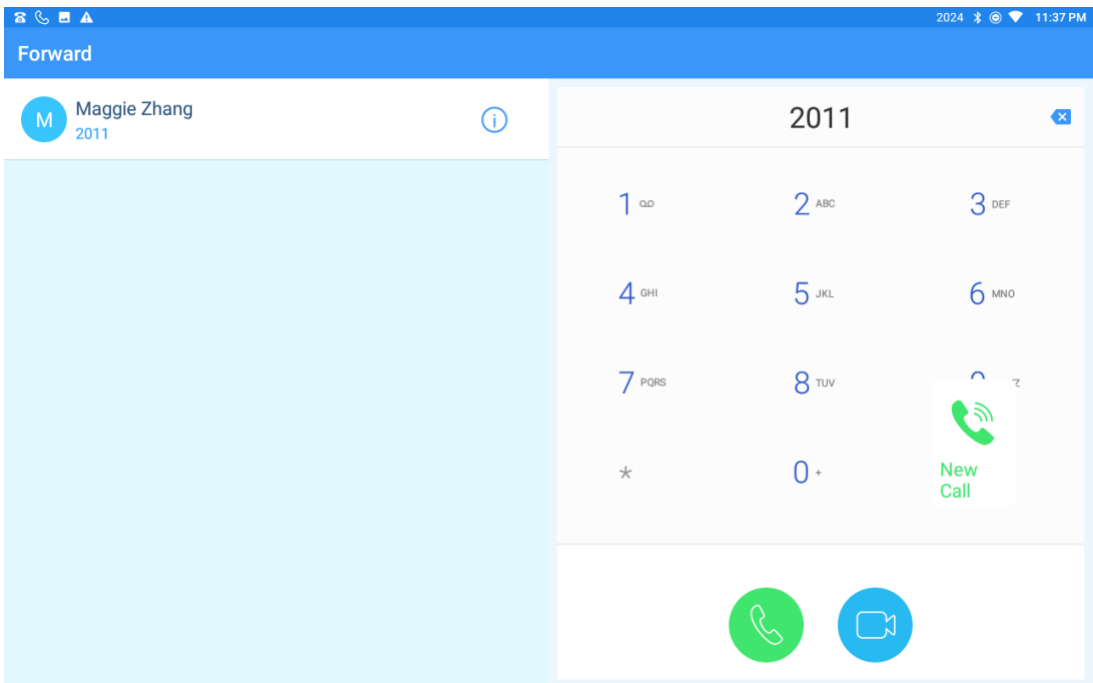

Note: Call Transfer function need IPPBX supports.

5.1.3 Explanation of function buttons during calls



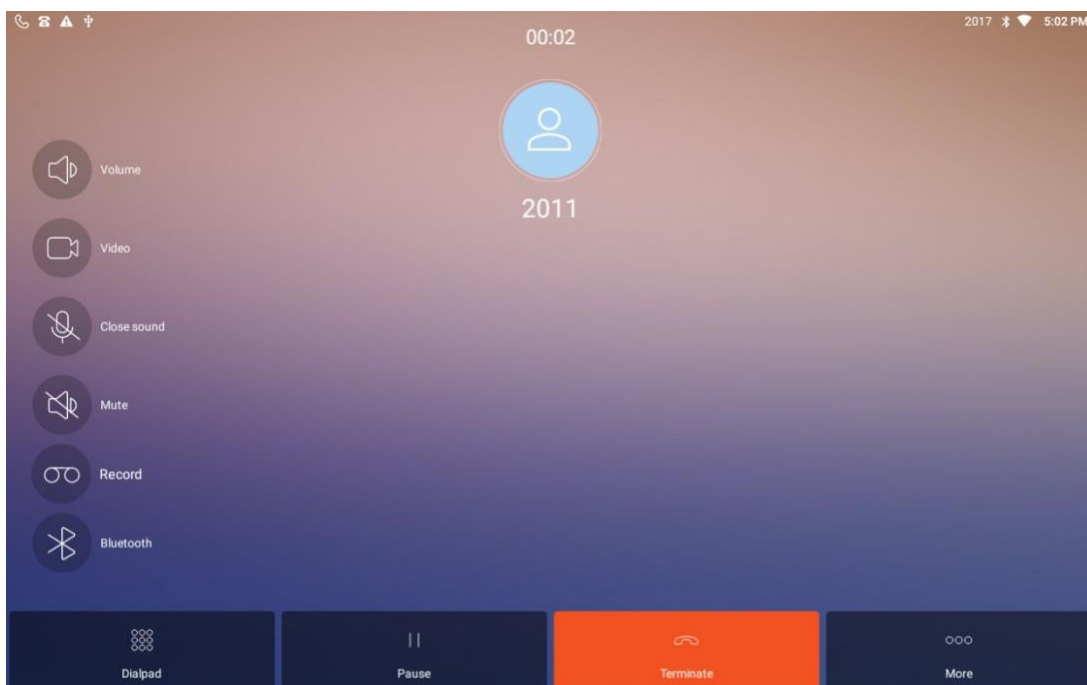

5.1.3.1 Explanation of function buttons during audio calls

During audio calls, below menu buttons will be displayed. They are hidden by default, but once click on the calling screen, the menu buttons will occur again.



Explanation of function buttons in calling screen.

Function buttons	Description of functions
Volume	Click the "Volume" button to adjust the volume during calls.
Video	Click the "Video" button, caller can send a video

	invitation to the other side, once the other side accepts, then the original audio call will turn into a video call.
Close sound	Click "Close sound" button then it will turn to be highlight  , it means local microphone will be disabled, the other side cannot hear, click the button again then it will revert.
Mute	Click "Mute" button, then it will be highlight  , it means to disable the sound from the other side, user can't hear from the other side, but the other side still can hear user. Click the button again then it will revert.
Record	Click "Record" button, then it will be highlight  , voice from both sides will be recorded. When an USB disk is inserted into the phone, the recording voice file will be automatically stored in the USB disk. Without USB disk, the files will be recorded in the phone. Click the button again, the recording will be stopped.
Bluetooth	When using Bluetooth for calling, this button is highlight.  , click it again can disable  , then it will be switched into handfree mode.
Dialpad	Click "keyboard" to pop up the numeric keyboard during the call, and you can dial twice

Pause	During the call, click "Pause" to maintain the original call, listen to the hold sound, and click again to resume the call
More	Click "more" to display more functions, as shown in the figure below.

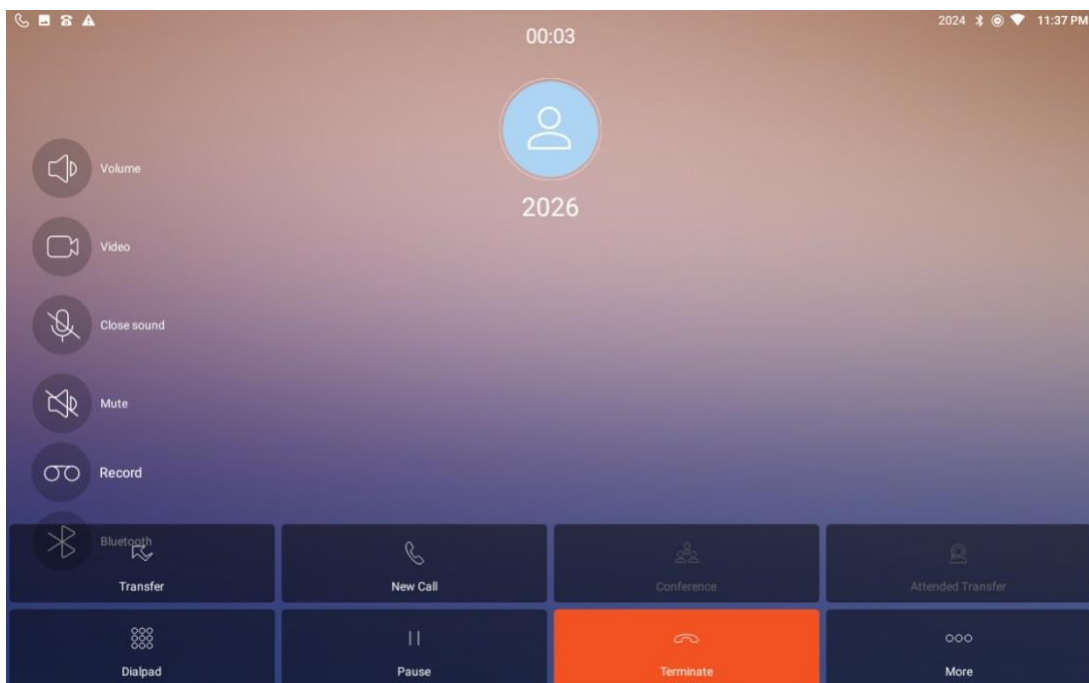

Functional button	Function Description
Transfer	<p>During the call, A calls B, B can click "Transfer" , input C number and call out, that is, transfer A to C, B to hang up, A C begin to talk.</p> <p>Note: the registered PBX server is required to support transfer function.</p>

New call	<p>During the call between A and B, the terminal B clicks "new call", enters the number C and exhales, the call between A and B is maintained, A listens to the hold tone, and B and C speak.</p> <p>When B and C finish the call, B clicks "restore" to resume A and B's call.</p>
Conference	<p>The device supports maximum 6 audio parties conference call.</p> <p>Operation method: this terminal equipment B calls A, AB calls.</p> <p>B click "new call" enter C number and call out, BC call.</p> <p>B click "multi-call" to realize ABC multi-call.</p> <p>The same method can be added to the D number and other multi-party calls.</p>
Allowed transfer	<p>During the call, A calls B (the terminal device), B can click "Add numbers", input C number and call out, C answers, B C calls, B then click "Allowed transfer" to transfer A to C, B hangs up, A and C talk.</p>



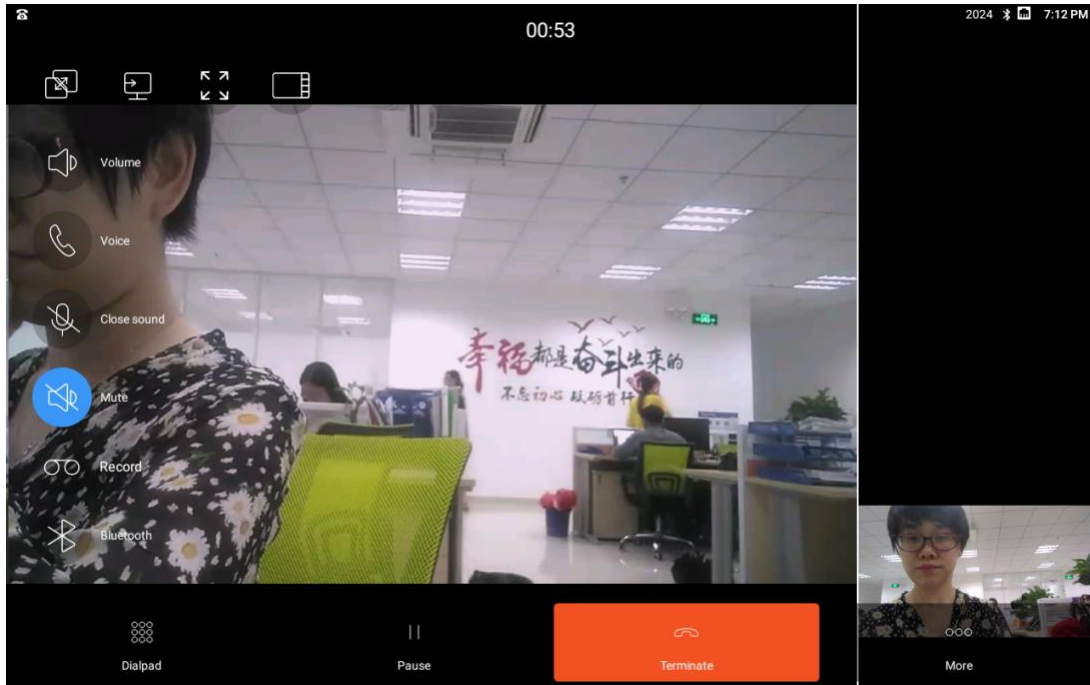

5.1.3.2 Function button description in video call





In an audio call, the following menu button will appear. The default menu button will be uninstalled. Click video call interface and the menu button will appear.





The function menu on the left side in video calls is basically same as the function menu in an audio call. Please refer to the description of function buttons in the audio call in section 5.1.3.1.

The function menu above only relates to video calls, which are explained in detail here.

Function Buttons	Function Description
 Dual screen display	When it' s displaying both the main stream and the sub stream, click  to output the sub stream through HDMI to a TV or other device, while the device only displays the main stream video. Click this icon again to cancel.
 Send sub stream	The device obtains the sub stream through accessories. Click  to send the auxiliary stream to the opposite device.

	<p>Click this button again to cancel. Note: before video call, the  button can only appear when "Enable sub stream" is turned on in the Call Settings. Please refer to section 4.3.2.5 for details.</p>
<p> Full size display</p>	<p>Click "Full screen display" to display video in full size. Double - click video screen can also achieve full screen display. Click this again to cancel full screen displaying.</p>
<p> Layout switch</p>	<p>There are three pictures in video call, which are: video sent from the opposite end (displayed on the main interface by default), local video (displayed on the lower right corner by default), and sub stream screen (displayed on the right side by default).</p> <p>Click "Layout switch" to choose which screen to be in main interface.</p> <p>It can be achieved by clicking video screen.</p>
<p> Show video parameters</p>	<p>Click "Show video parameters" and it will display local and opposite video parameters. Click it again to cancel. Note: it needs to enable "Show video parameters" in call Settings.</p>

	Please refer to section 4.3.2.10 for details.
 Voice	Click  , then the video call will turn to an audio call.

5.1.4 Call Log



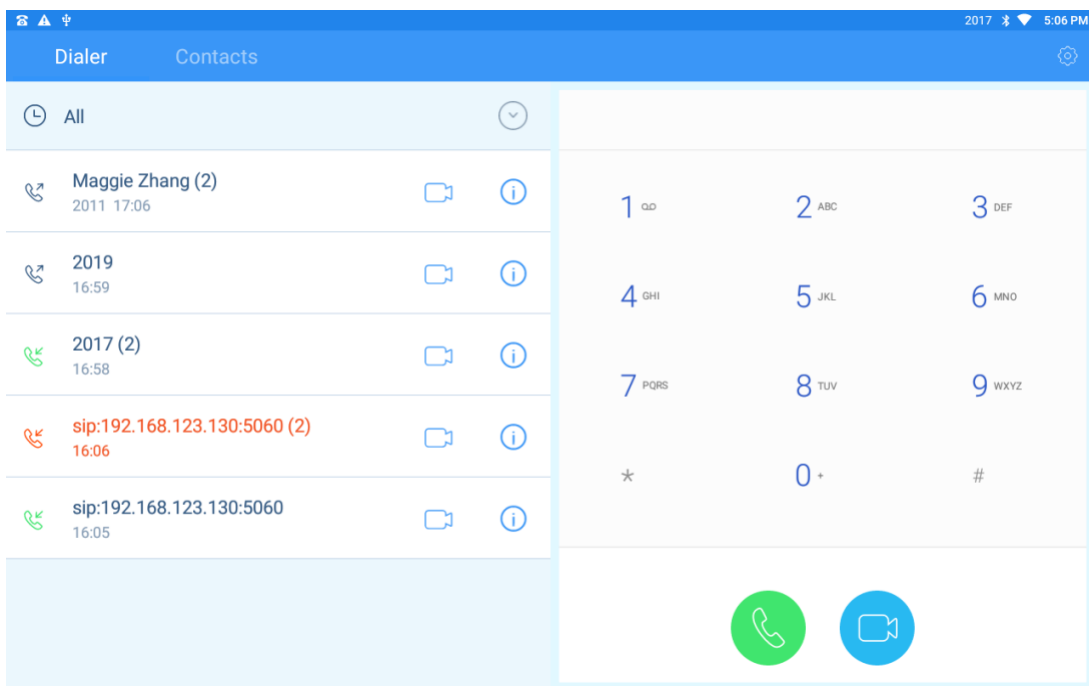

5.1.4.1 All Call Log

Click the shortcut icon "Dialer" or "Call Log" on the main screen, to enter the "Call Log" interface, as shown in the figure below:



The "Call Log" and the "Dialer" are on the same interface. The left side displays all the Call Logs by default, and the right side displays the dialer keyboard.

★ Call Logs include: Dialed calls, Received calls, Missed calls;

- ★ Call Log list shows phone number, name (non-stranger calls), outgoing time or incoming time;
- ★ The icon for received call is green  , the icon for missed call is red  , and the icon for dialed call is black  .
- ★ Click the button  to view the detailed call information, including the call duration and the date and time when the call started.

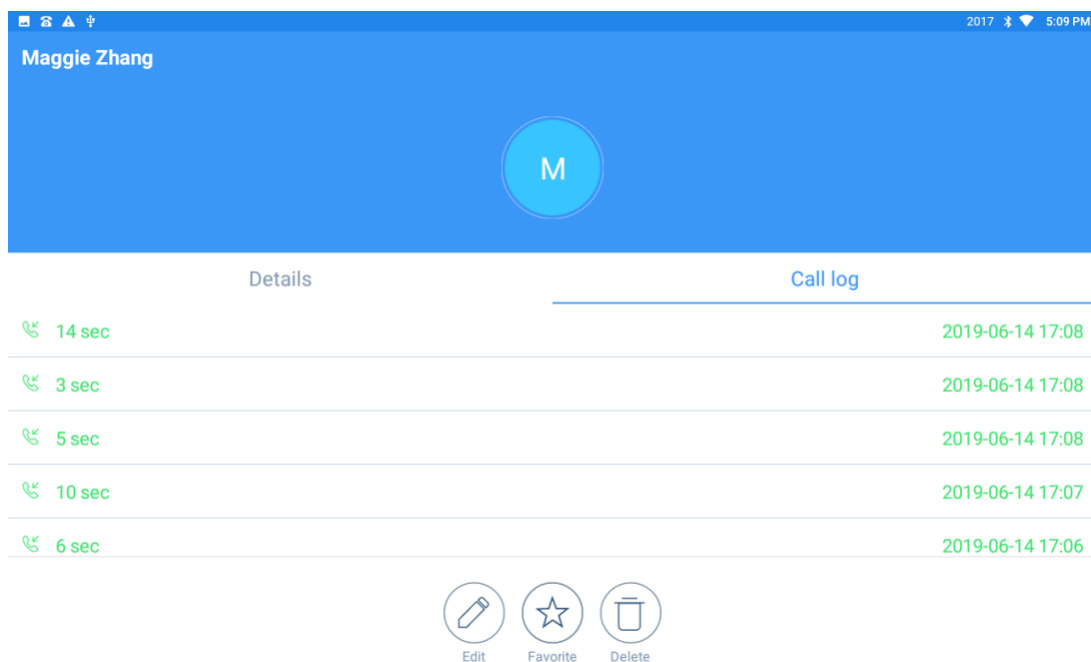

5.1.4.2 Function options of Call Log

1. Call initiated by Call Log

Click one call record in the Call Log list to initiate an audio call, and click the  button to initiate a video call.

Or long press a call record, click "Video call" or "Audio call" in the pop-up dialog box to initiate a call.

2. Delete Call Log

1) Delete one single call record

Long press certain call record and click "Delete logs" in the pop-up dialog box.

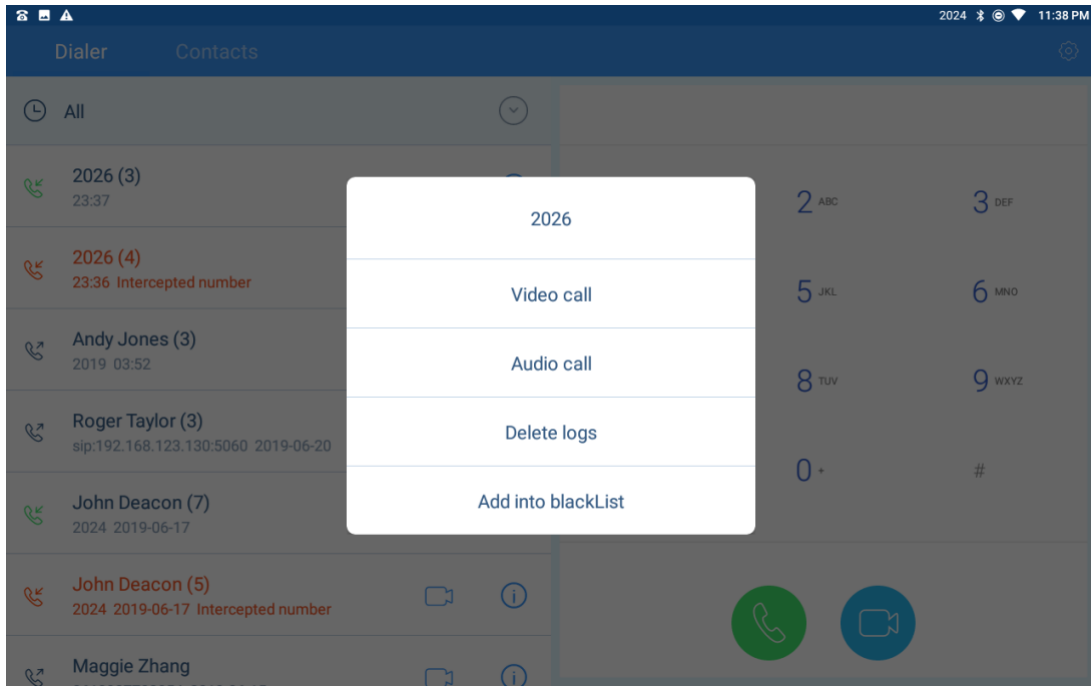

2) Batch deletion of call records

Click the Settings button  in the upper right corner of the Call Log interface, and select "batch delete records" in the dialog box that pops up, and the picture below appears.

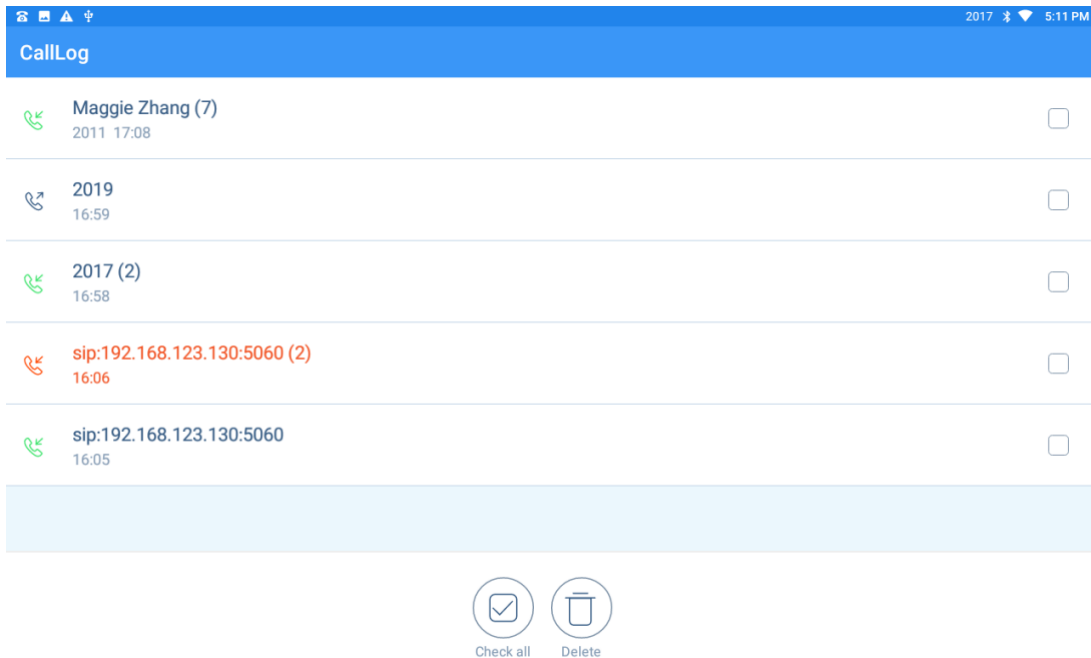

Check the call record to be deleted and click delete.

3. Add into the blacklist

Long press a certain call record, in the pop-up dialog box, click "Add into the blacklist", you can add the number to the blacklist.

If this number has been added to the blacklist, the "Remove from blacklist" option can be selected when long pressing the call record.

To use the blacklist function, first turn on the "Harassment interception" in the "Call Setting". For the specific black and white list Settings, please refer to the "Harassment interception" Settings in section 4.3.2.3.

4. Recording files

There is a shortcut to enter recording files in the call recording interface. Click the Settings button  in the upper right corner and select "Recording files" to open the folder where recording files are located.

The picture is as below:

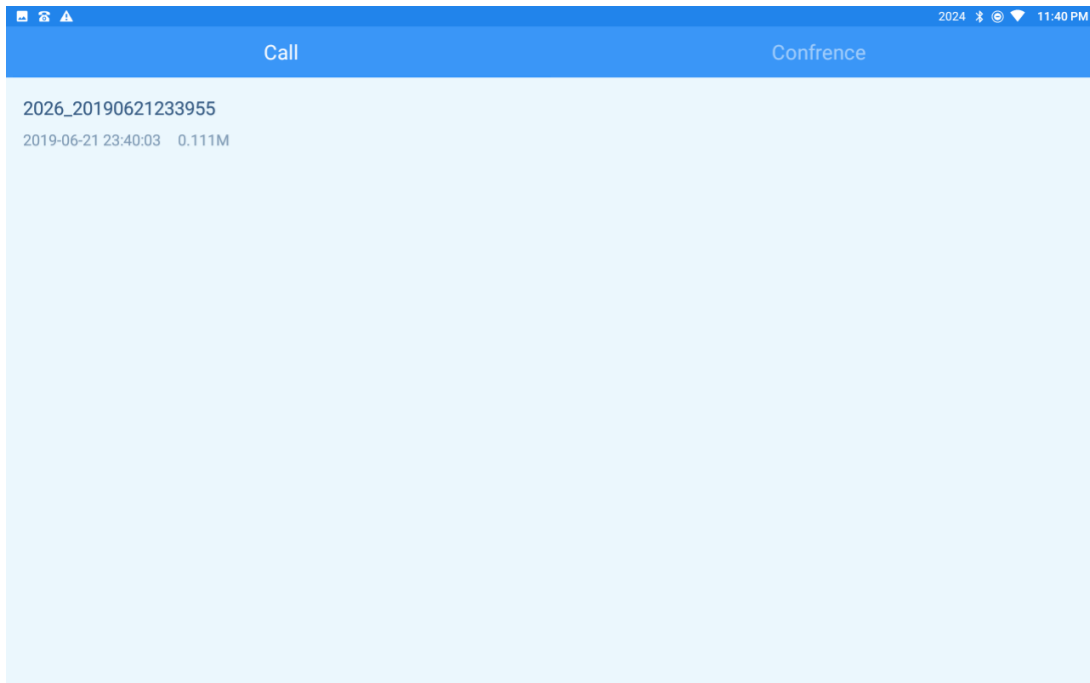

5.1.4.2 Missed Call

The Call Log interface displays all the call records by default, we can also choose to display missed calls.

Click the icon on the right of "all calls"  and tick "missed call", it's shown as below.

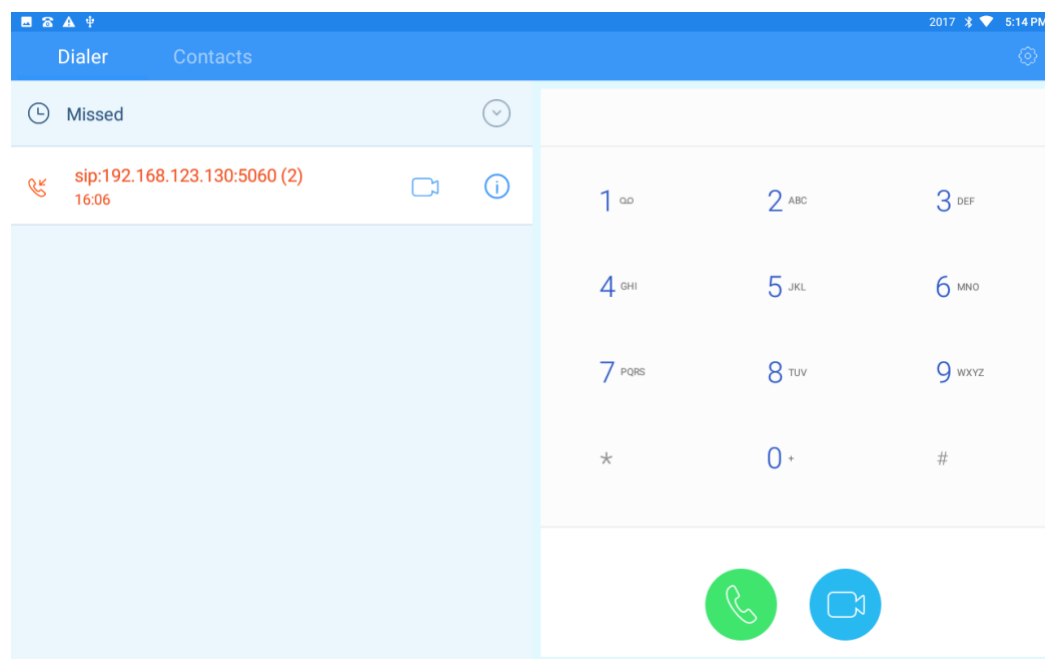
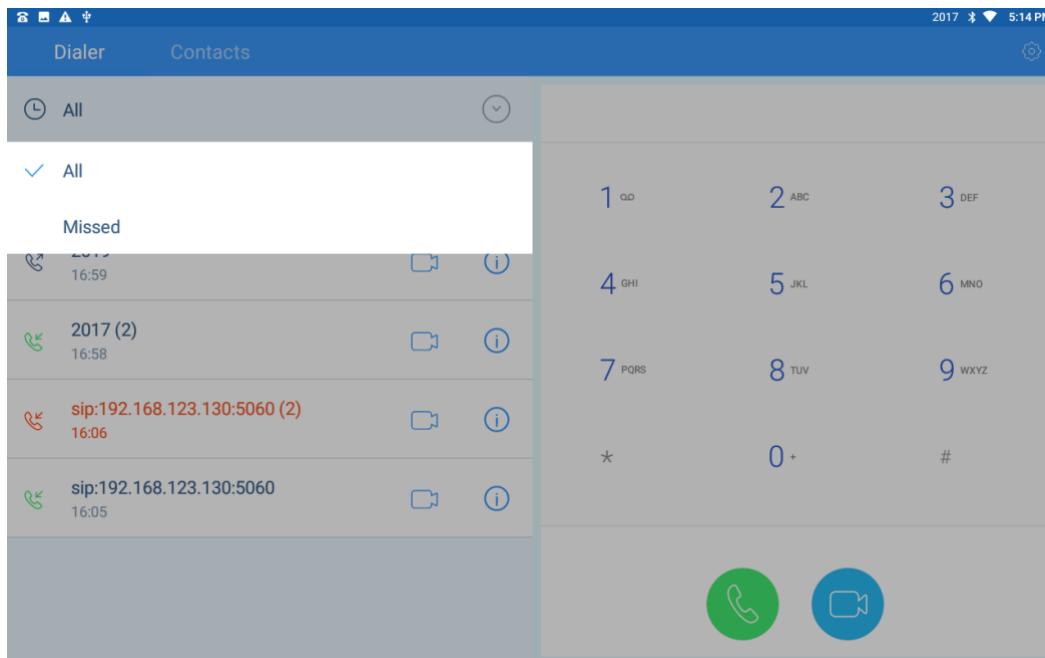

Call Log - Missed call, check all missed calls.

If we have got missed call, the indicator light in the upper right corner will flash red, and the notification bar in the upper left corner will display that there is a missed call. Drop down the notification bar to view, click the notification to jump to the call record interface.

5.1 Contacts

Click the shortcut icon of "Contacts"  on the main screen to enter the "Contacts" interface.

"Contacts" includes Favorite Contacts, Enterprise Contacts, Mobile Contacts.

And also with groups, black and white list function.

5.2.1 Contacts

Contacts is displayed on the lower left side of the "Contacts" interface. Scroll up to see more.

Click contacts, and the contact details can be displayed on the right side of the interface.

5.2.1.1 Import local contacts

The iVoice 210 supports importing contacts from the LCD interface or Web page.

Import from the LCD interface:

- 1) Put contact files in CSV, VCF and XML format into USB disk or SD card.
- 2) Insert USB disk or SD card into iVoice 210 phone.
- 3) Open the file manager and copy the contact files of USB disk or SD card to the root directory of iVoice 210 phone (that is, the directory in the current interface of the file manager). See 5.4.2 for file manager usage
- 4) In the contact list interface, click the menu button  in the upper right corner

to pop up the menu as shown below

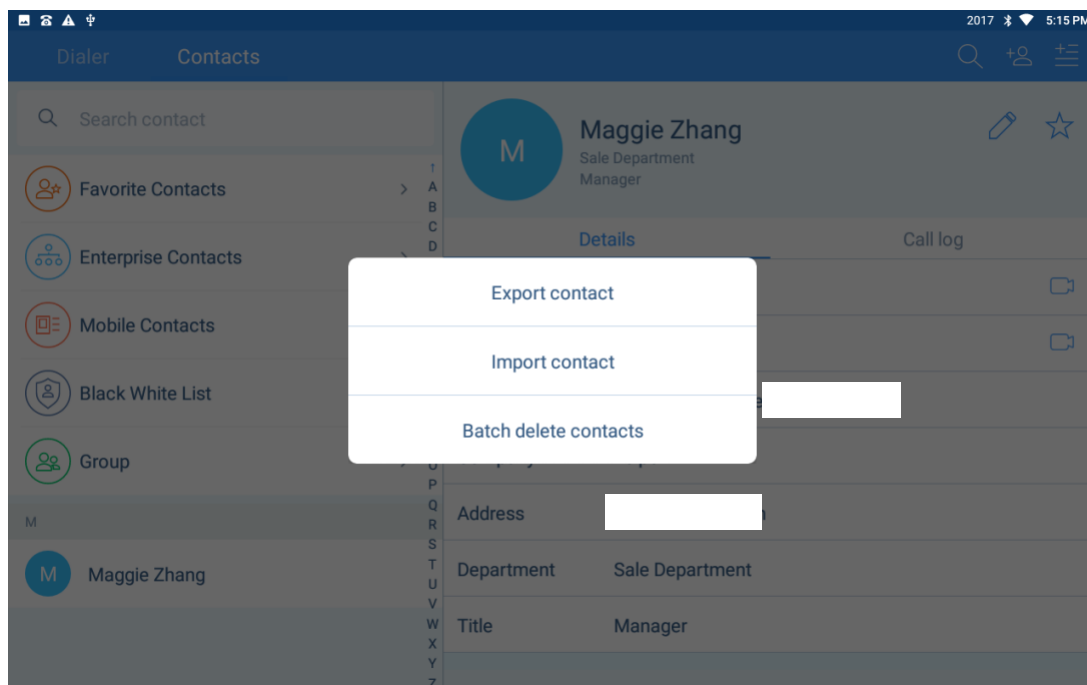

5) Select "Import contact" and the phone will search the contact file and pop up a list. Click and select the contact file you want to import.

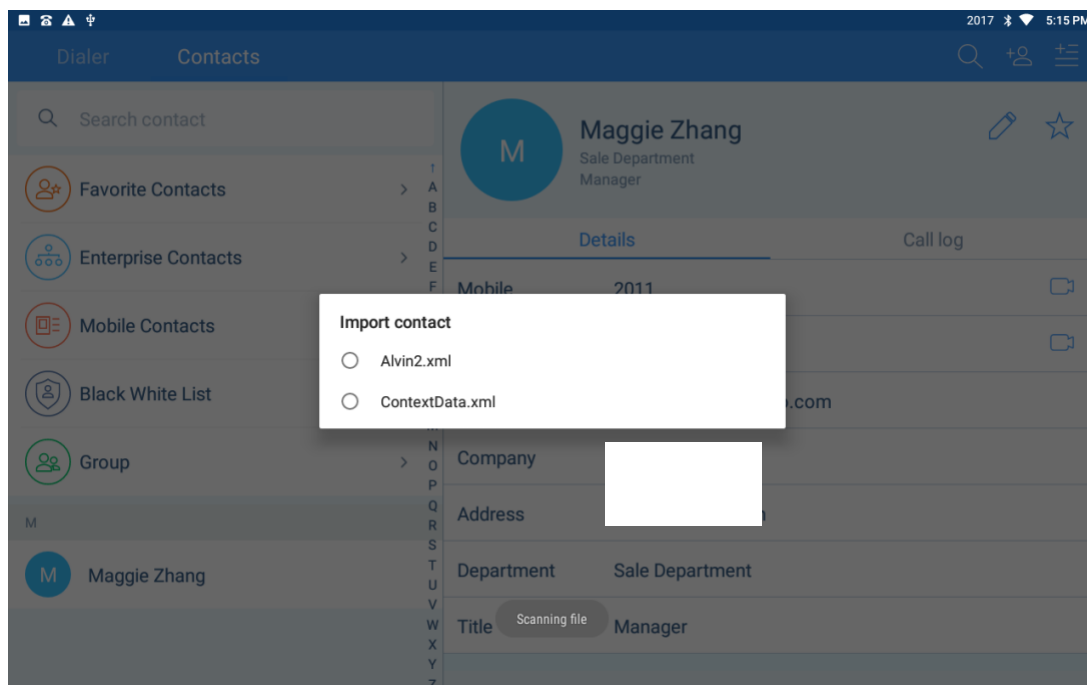

6) Drop down the status bar to view the importing progress, as shown in the figure below:

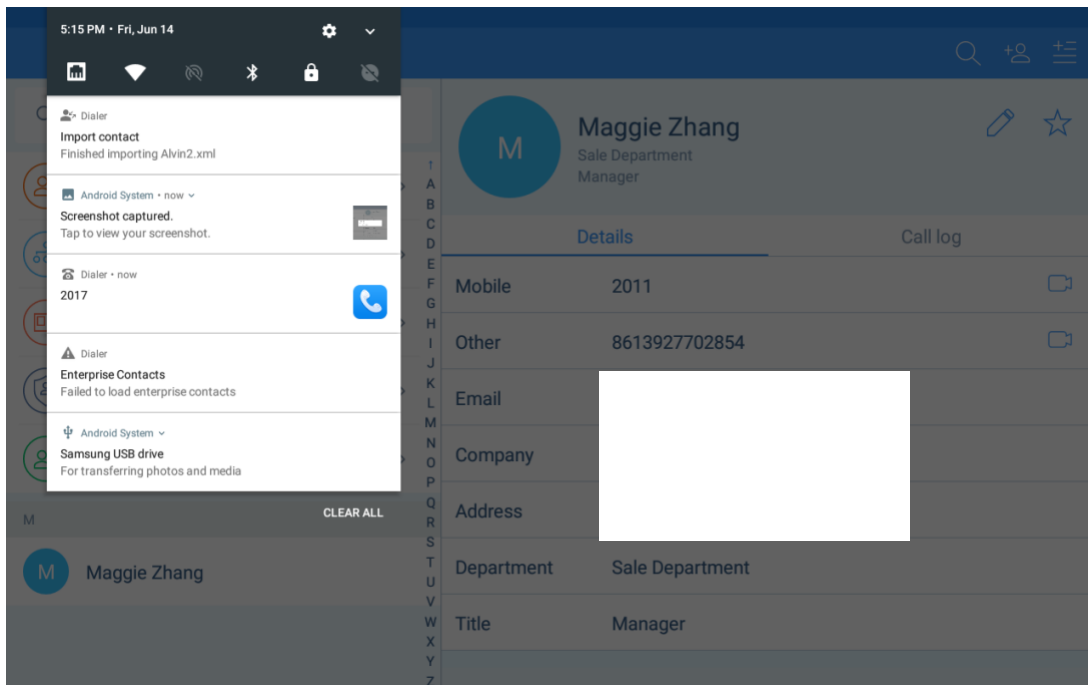

Import contacts from web (support VCF, CSV, XML format)

- 1) Log into the web (input phone IP, input account and password to log in) and enter the "Contact" menu;
- 2) Click browse, select contact files in VCF, CSV and XML format, and click import.
- 3) After Web import, the importing progress can be checked through the LCD interface.

The Web also supports downloading templates in VCF, CSV, and XML formats, which you can use to edit contact files.

5.2.1.2 Export the contacts

Export from the phone' s LCD interface (only supports exporting VCF format) :

- 1) In the contact list interface, click the menu button  in the upper right corner,

and click "Export contact" in the pop-up menu, and the system will pop up a confirmation dialogs, as shown in the figure below:

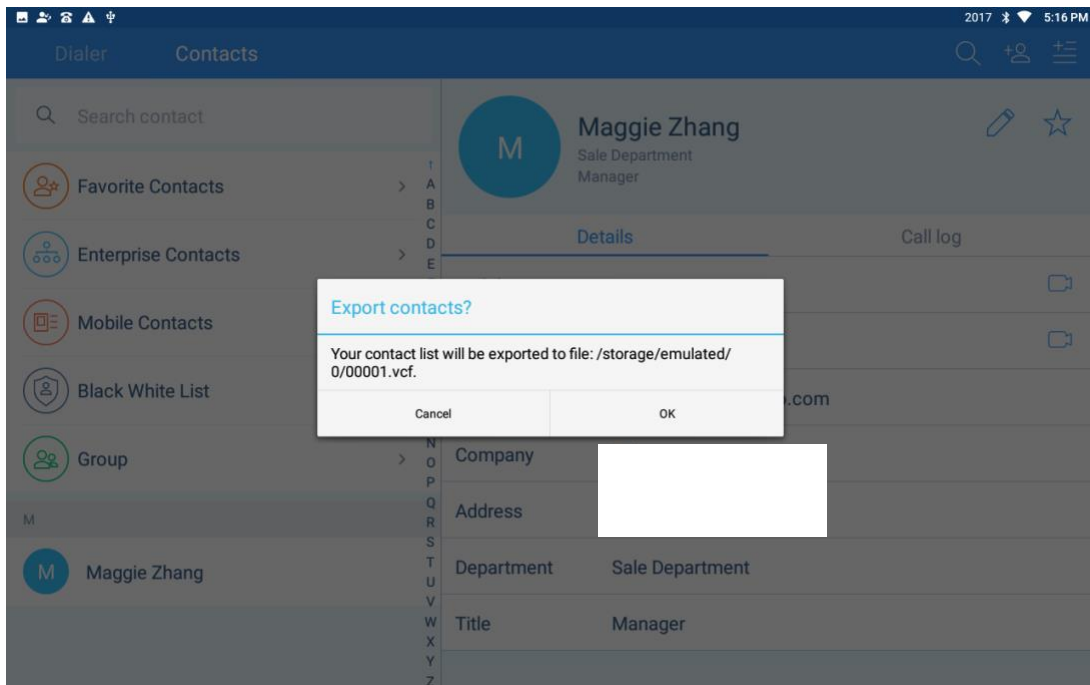

- 2) Click "OK" to export the local contacts to the root directory of the phone;
- 3) Pull down the status bar to check the export progress.

Export contacts from web (support VCF, CSV, XML format) :

- 1) Log into the web (enter phone IP, enter account and password to log in) and enter the "Contacts" menu;
- 2) select the type of exported file under the contacts export, including VCF, CSV and XML;
- 3) Click "Export", the web interface will prompt "Processing, please wait, the LCD interface of the phone also has the prompt of contacts exporting;
- 4) After the contact list is exported, click "Click download" in the web interface to download the exported contact list.

5.2.1.3 Contacts-Add contact

After entering the contact interface, click the icon of adding new contacts  in the upper right corner, and the interface of adding contacts is as follows:

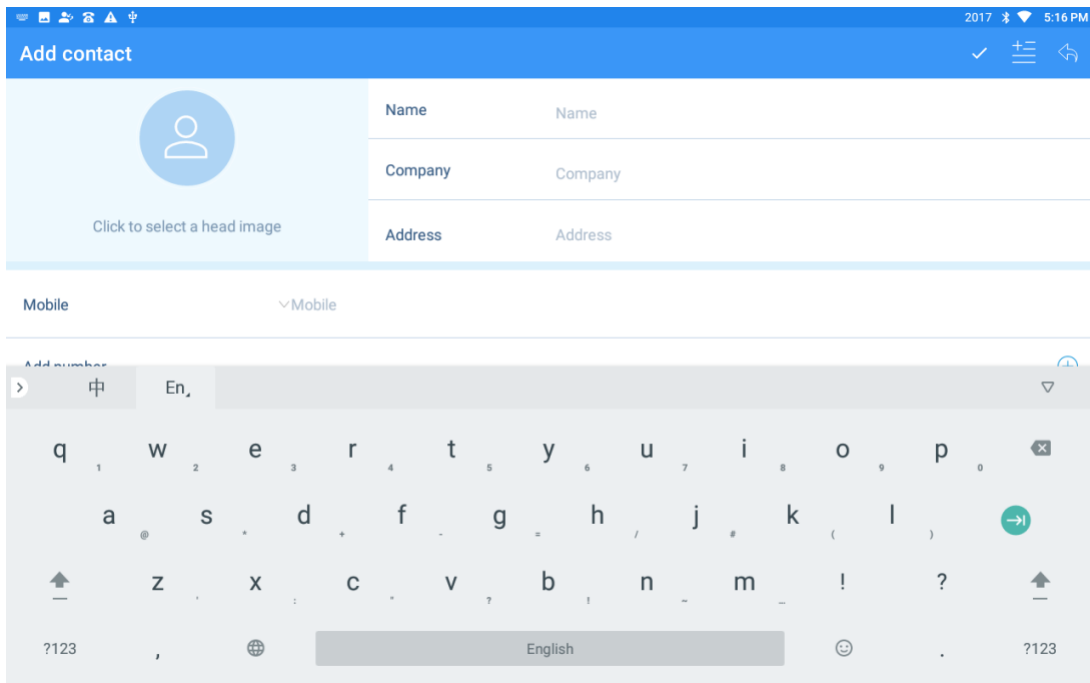

Description:



1) Head image Settings: head image can be added by taking photos or from photo album.

If not modified, default to the last word of the name as the head portrait.

2) Number: this field displays the phone number by default. Click the small arrow

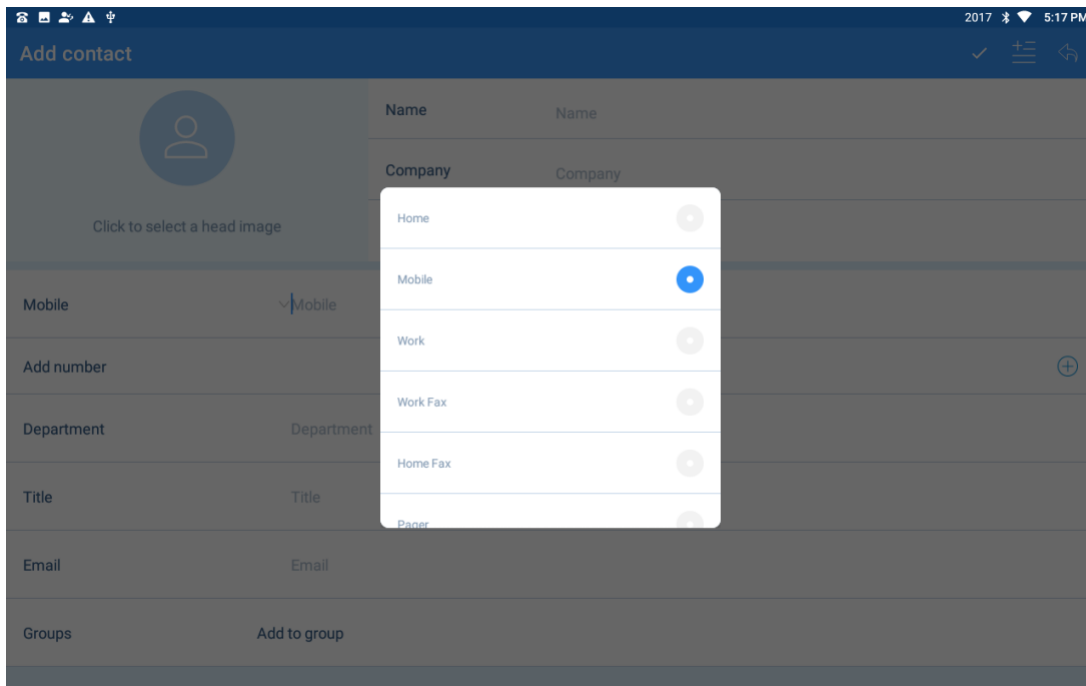
▼ after "Mobile" to select which number should be displayed. Shown as below.



- 1) Add number: can add multiple Numbers to the contact.
- 2) Add birthday and remark: in the add contact interface, click the menu icon  in the upper right corner to pop up the fields "birthday" and "remark" that can be added.
- 3) Please fill in other information literally, only the telephone number is mandatory.
- 4) After finish filling in, click the finish button  in the upper right corner to add the contact.

5.2.1.4 Add contact from call log

In addition to adding new contacts to your contacts list, you can also add contacts directly from your call log.

The steps are as follows:

- 1) Enter the call log interface and click the button  after stranger number to enter below interface.

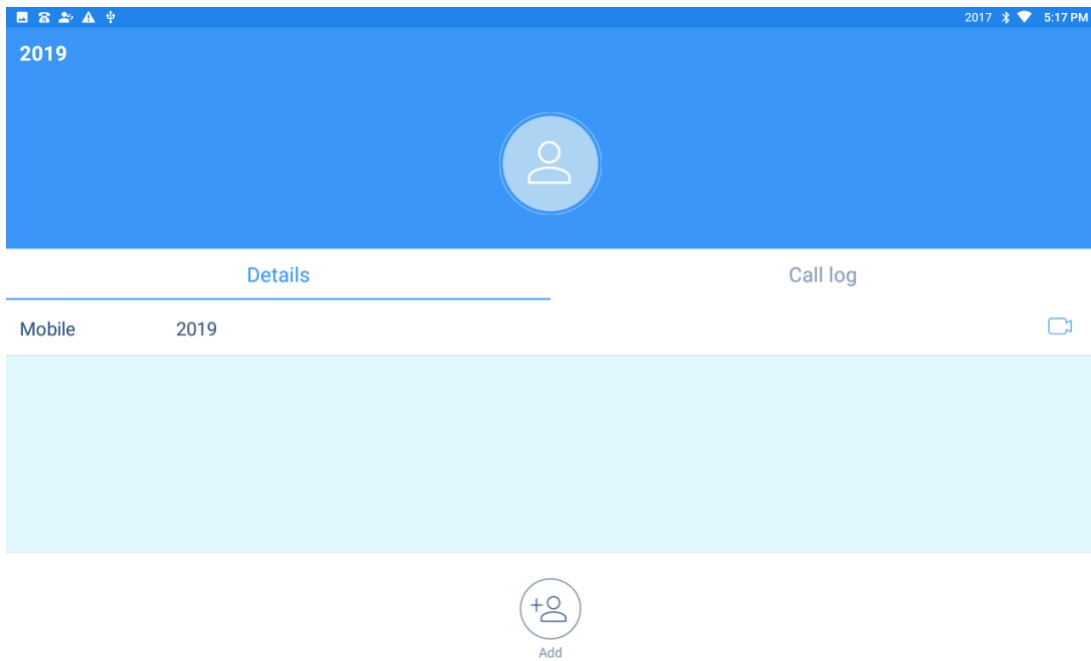

1) Click Add, and the dialog box will pop up as shown below. You can select "Add new contact" or "save to the existing contacts".

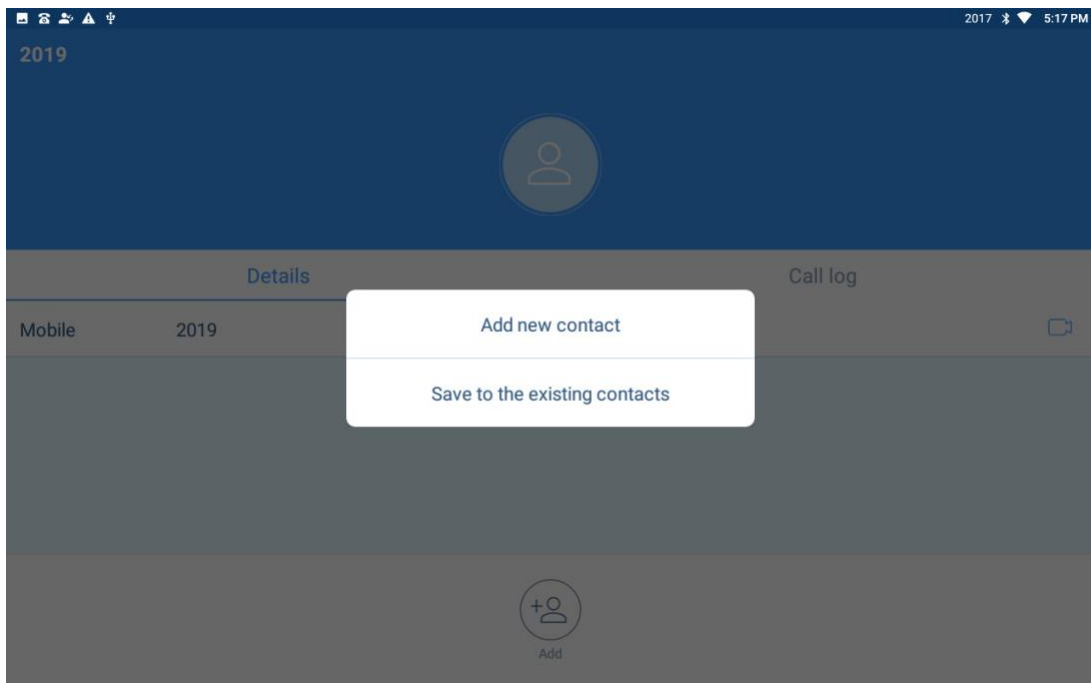

2) Select "new contact" and jump to the interface of adding new contact. Please refer to section 5.3.1.3 for the method of adding new contact.

3) Select "Save to the existing contacts" to jump to the local contact interface.

Click "select contacts" to jump to the edit interface of the contact. The number will be automatically added to the contact information.

If you do not need to modify other information, click the finish button  in the upper right corner to complete the addition.

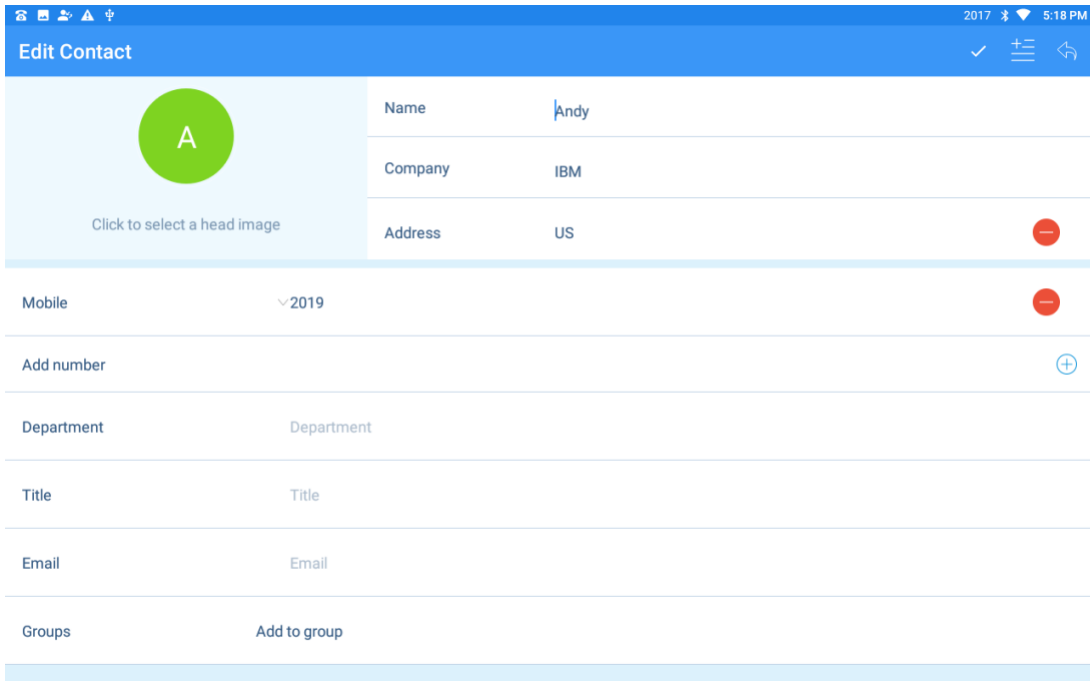



Field	Value	Action
Name	Andy	
Company	IBM	
Address	US	Remove
Mobile	2019	Remove
Add number		Add
Department	Department	
Title	Title	
Email	Email	
Groups	Add to group	

5.2.1.4 Local call log - modify contacts

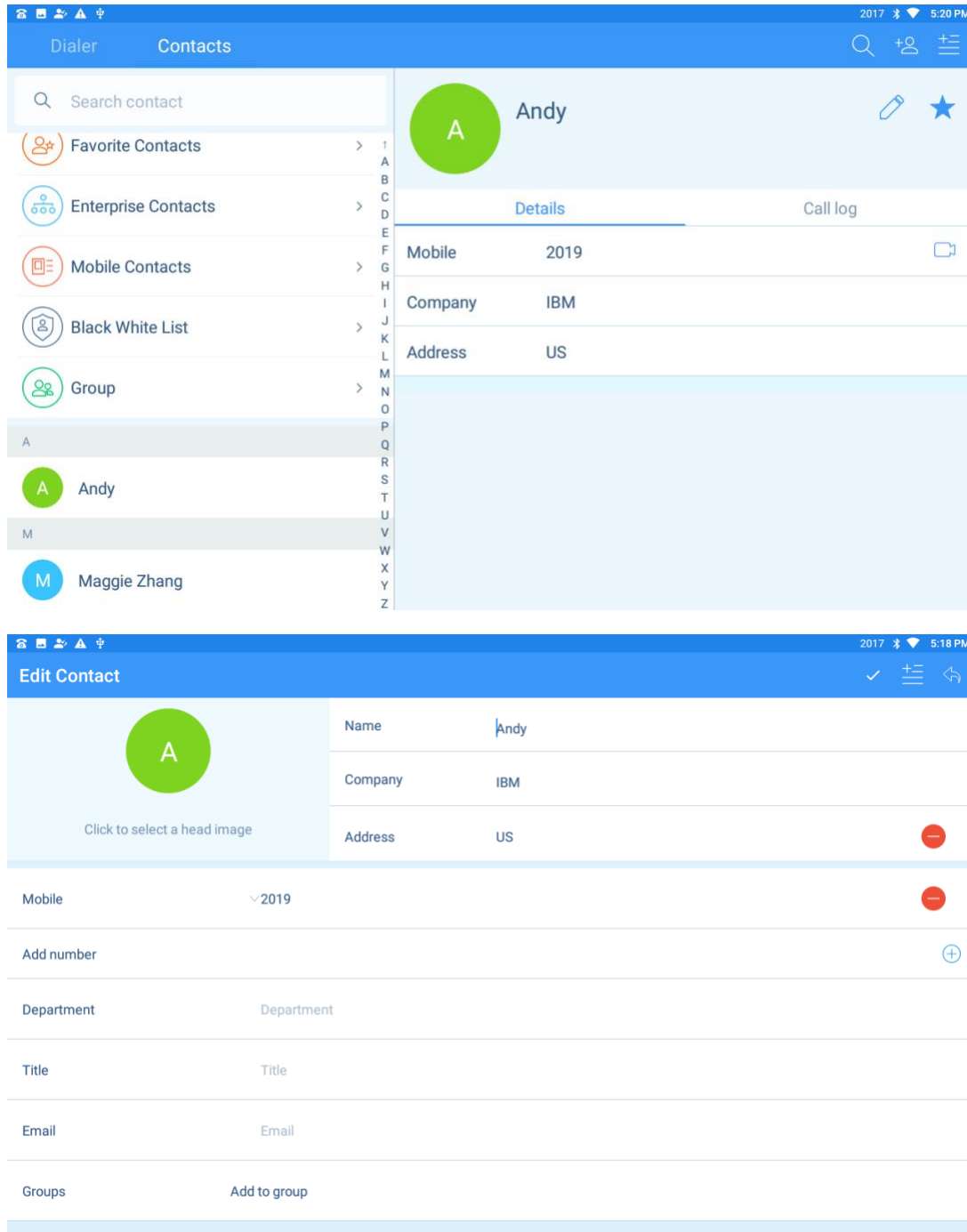
In the contact details screen, click the edit button  on the right side of the contact head image to enter the contact editing interface, as shown below:





Description:

- 1) Press red button  to delete the information of the corresponding row;
- 2) To supplement information or modify, please refer to the description of adding contact in section 5.3.1.3.
- 3) After modification, click the finish button  in the upper right corner.

5.2.1.5 Contacts - delete contacts

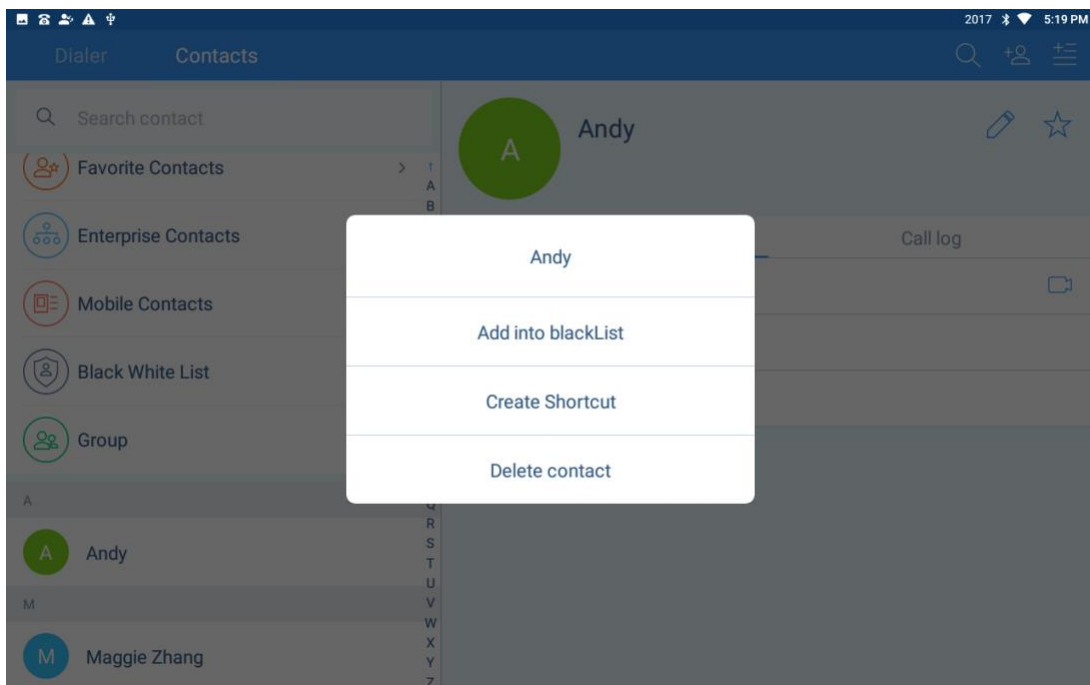
Delete contact: enter the contact list interface, long press a single contact in the local contact list, and click "Delete contact" in the pop-up menu to delete a single contact.



Batch delete contacts: click the upper right menu button  in the contact list interface, and select "Batch delete contacts" from the pop-up menu.

After selecting all or checking some contacts, click "Delete" to complete the deletion.

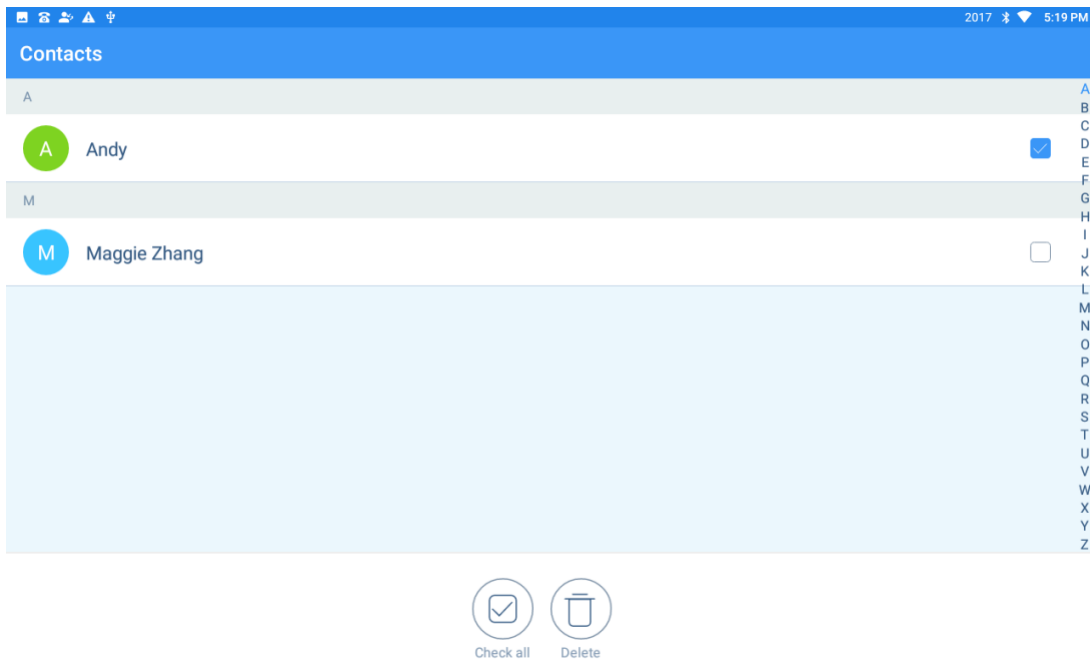

5.2.2 Enterprise contact

Enterprise contact setting

- 1) Log in to the web (input phone IP, account and password to log in), click the left menu "Contact" -- click the right menu "LDAP";
- 2) Select "Advanced contact";
- 3) Fill in the address, port, account and password of the enterprise contact server, and then click submit;
- 4) In the status bar of the LCD interface, you can see a sign of arrow, and use the drop-down status bar can check the update progress of the enterprise contact.

Enterprise contact view:

- 1) Enter the contact interface after setting the enterprise contact. Click "Enterprise contact" to enter this interface.

2) The enterprise contact is displayed in a tree structure. Click the department to open the contact in the department, and click the contact to view details.

3) In the enterprise contact interface, click the menu icon  in the upper right corner to pop up the menu of "update enterprise contact". Click to manually update the enterprise contact.

5.2.3 Mobile Contact

Sync phone contacts:

- 1) Enable device' s Bluetooth connection to connect with mobile. Details please refer to Bluetooth Settings in section 4.4 for the use of Bluetooth;
- 2) After the device is connected with the mobile phone via Bluetooth, the dialog box will pop up on the LCD interface, asking whether to synchronize the mobile contacts, as shown in the figure below:

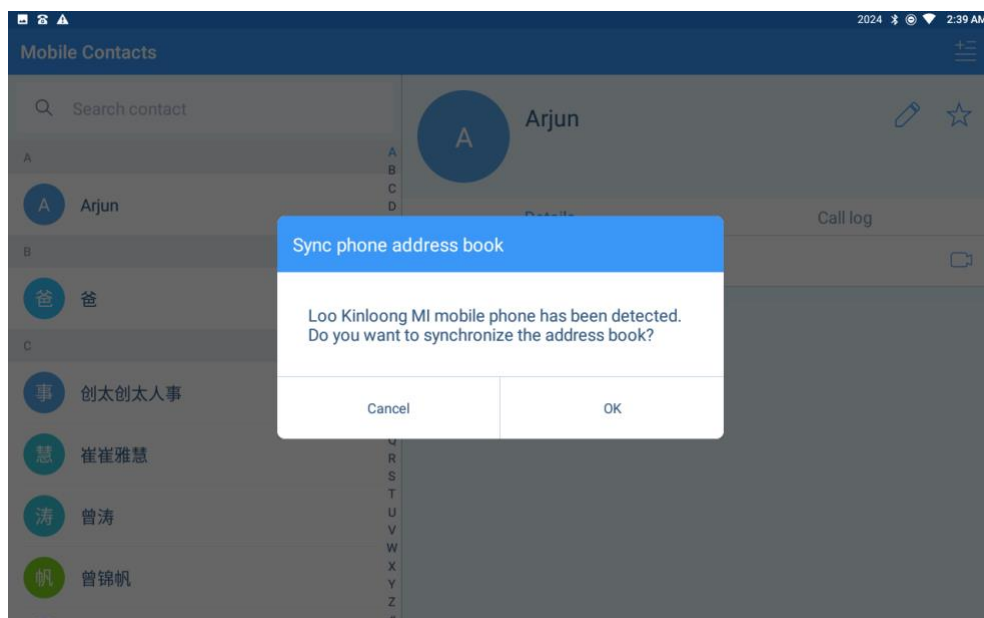

3) Click "cancel" then will cancel the synchronization of phone contact book.

Click "ok", and the device will synchronize the mobile contact to the device.

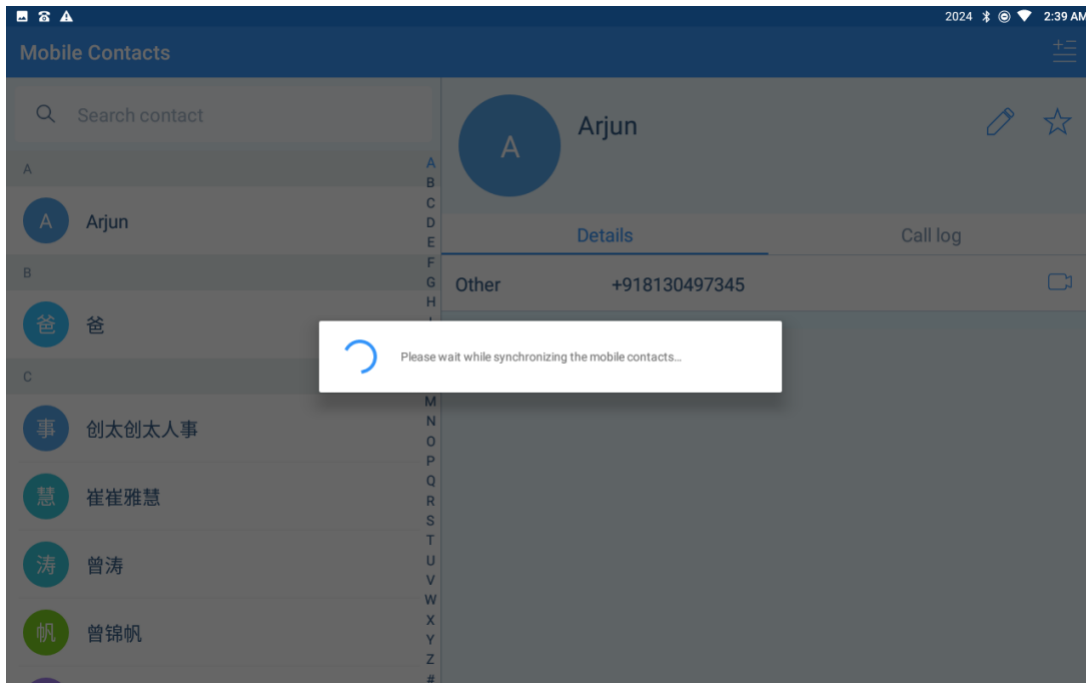

Mobile contact:

1) In the "Contact" interface, click "Mobile contact" to enter the Mobile contact interface.

The mobile contact list is displayed on the left side, and detailed information of each mobile contact is displayed on the right.

2) In the interface of mobile contact, click the menu in the upper right corner to manually synchronize the mobile contact, also can clear the mobile contact with one click.

4) Click and select "Sync phone address book", then will pop up the mobile's name which connected currently with iVoice 210 phone via Bluetooth. Select the mobile you want to synchronize, and then the synchronization will be completed in short time.

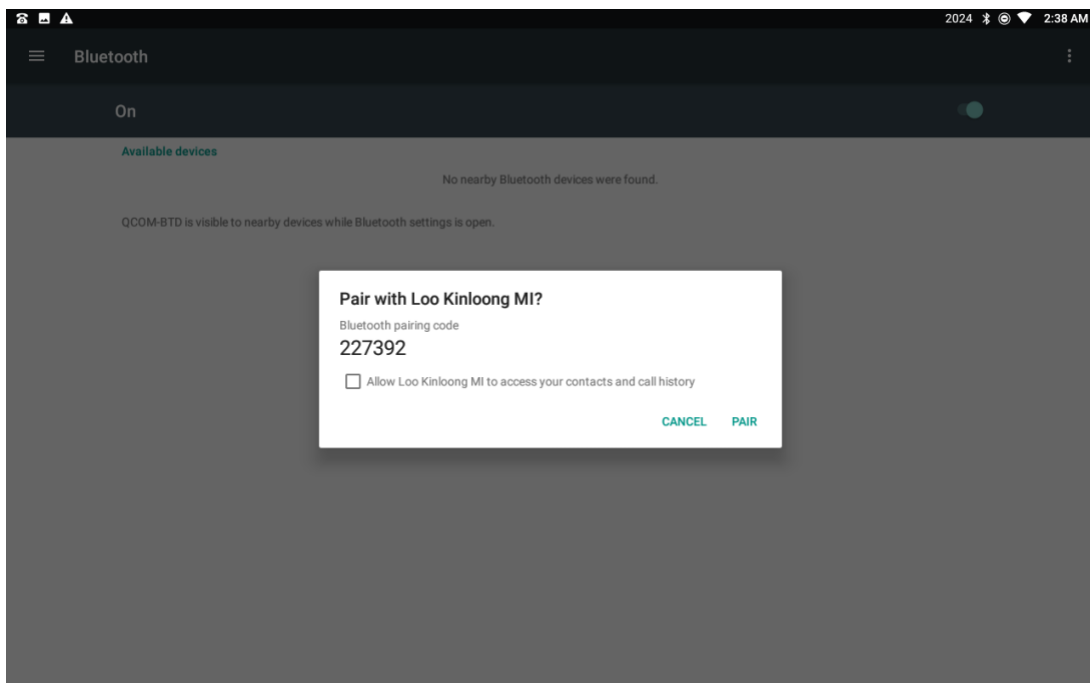
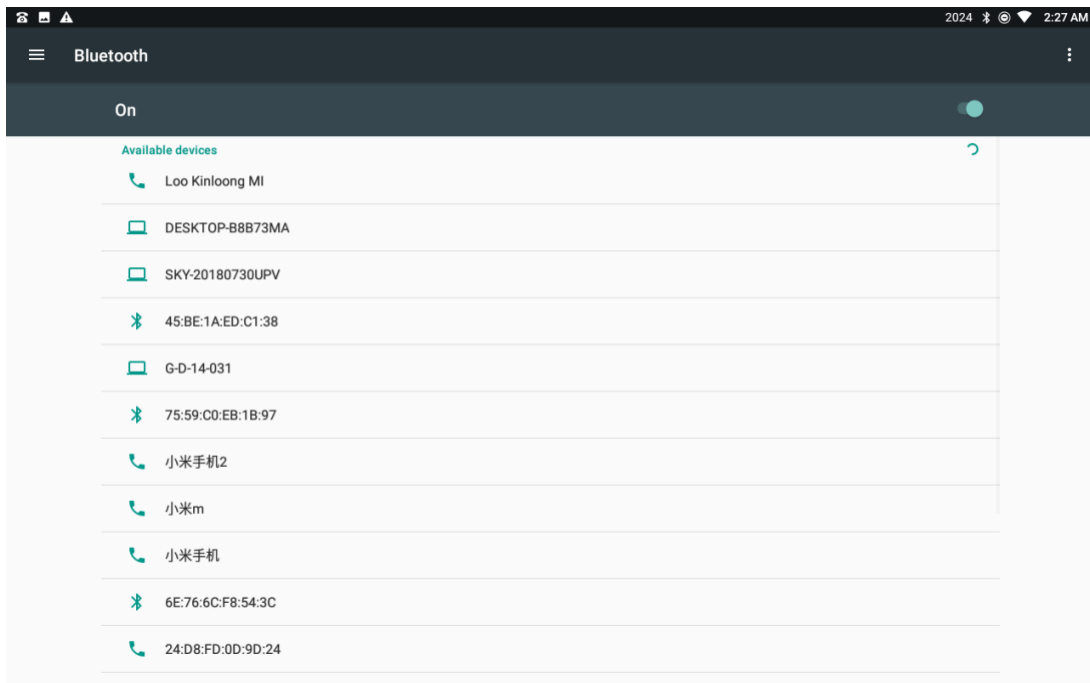

5) Click and select "Clear Mobile Contacts", a confirmation box will pop up to confirm whether to clear it or not, click "cancel" not to clear phone address book, and click "ok" to clear phone communication on the phone.

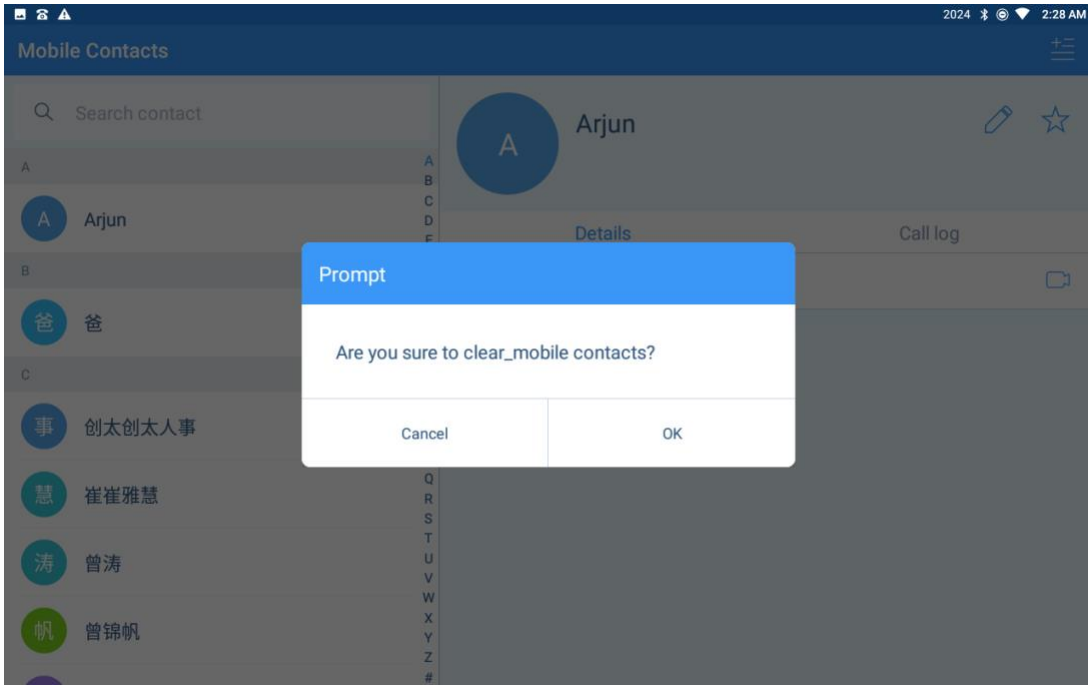

5.2.4 Favorite Contacts

Click "Favorites Contacts" in the contacts interface to enter the favorites contacts list, as shown in the figure below

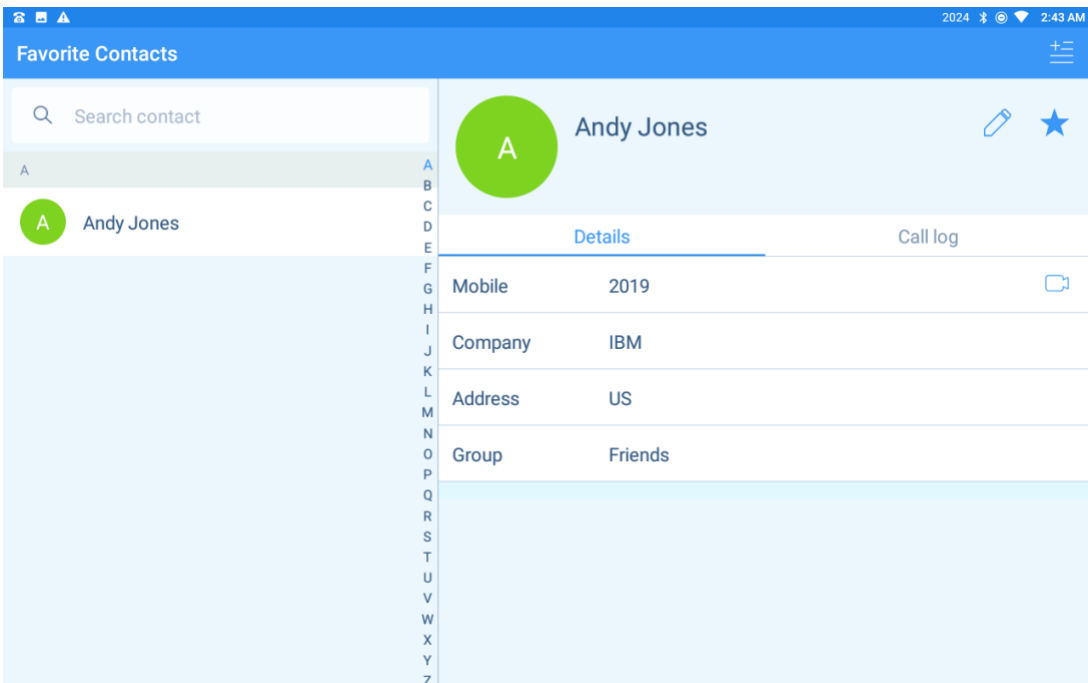

Add contacts to favorites:



Method 1: enter the favorites contacts interface and click the menu icon  in the upper right corner to select "add Enterprise Contacts", "Add Local Contacts" and "Add Mobile Contacts".

There is a small box on the right of each contact. Click the box to check the contacts to be added to favorites.

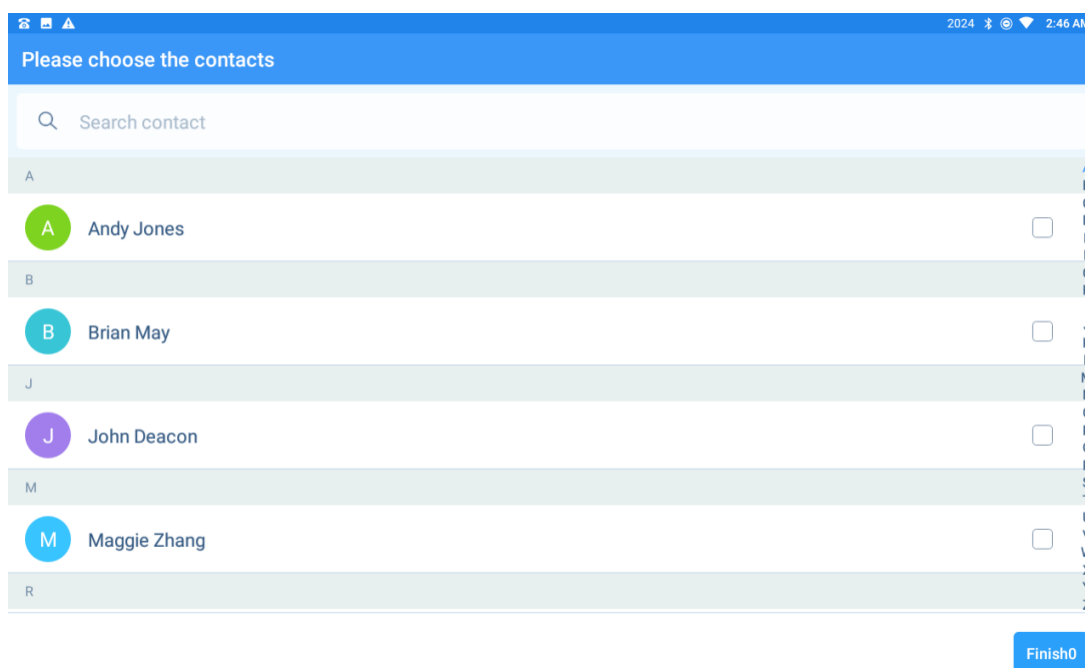
And click finish to complete the operation.



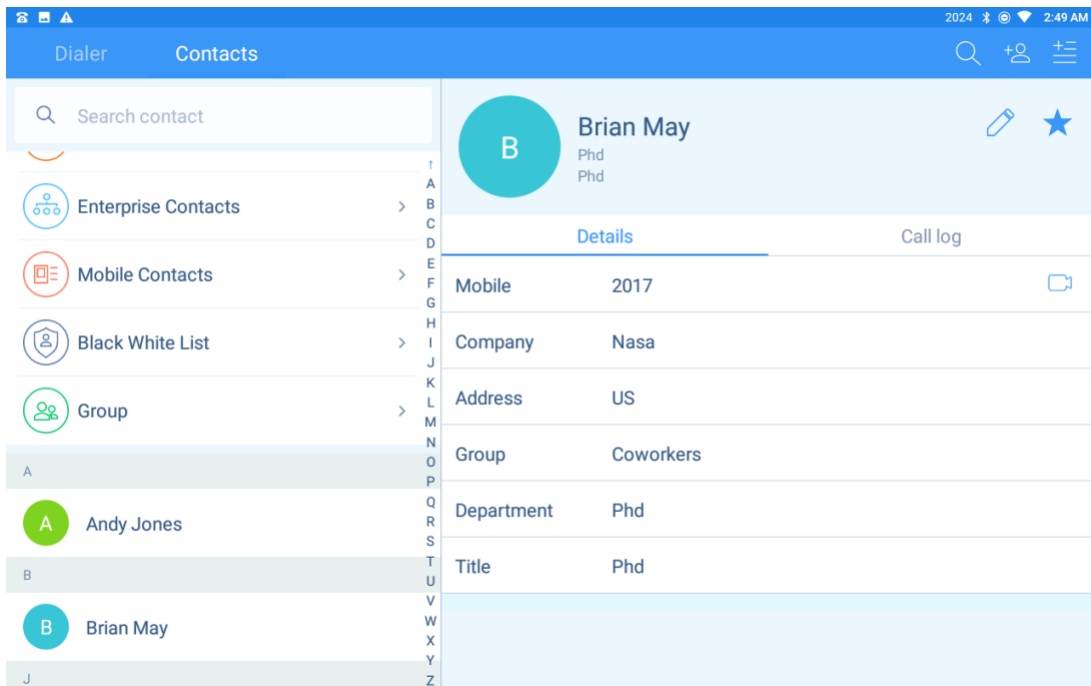

Method 2: Enter the Enterprise Contacts, Mobile Contacts or Local Contact, and click the contact to enter the detailed information interface.

There is a "favorite" button  on the right side of the contact's head image. Click "favorite" button to add the contact to "favorite". After clicking, the state of the button becomes , click the button again then can cancel the favorite selection.



Delete favorite contacts:

1. Delete single favorite contact: enter the favorites interface and click the contact to be deleted. In the contact details displayed on the right, click the favorites button  on the right of the contact's head image to cancel the favorites.

2, Batch delete favorites contact: in the favorites interface, click the icon  in the upper right corner of the menu, and select "Batch delete" from the pop-up menu.

After entering the delete interface, select all or select some contacts, and then click to delete.

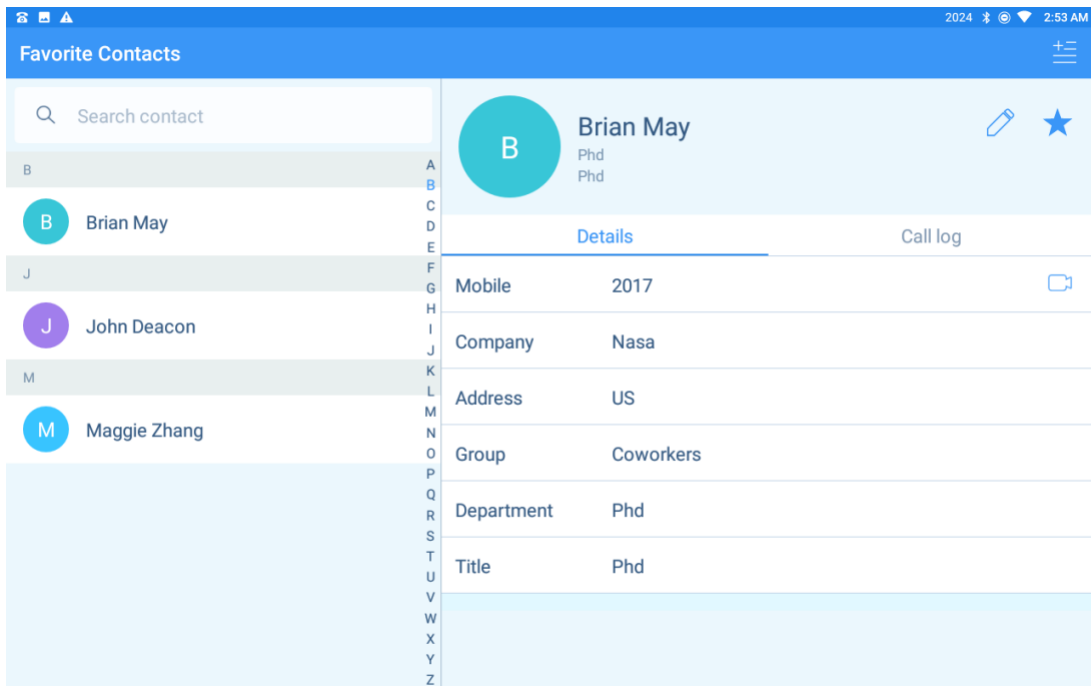

Note: to delete favorite' s contacts, just cancel favorites, no longer show in favorites, but contacts still exist.

5.2.5 Group

Grouping the contacts from Local Contacts and Mobile Contacts. Tap Group on Contacts interface, to enter Group interface. There are Coworkers, Family, Friends group by default. Picture shows as below.

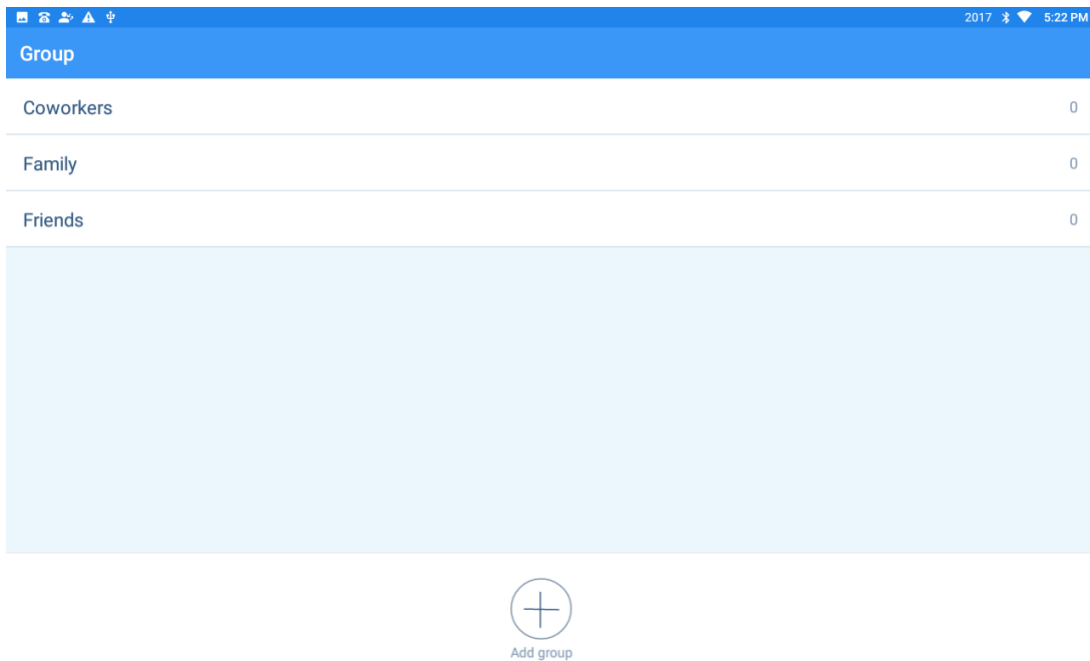



Add Group: On the bottom of Group interface, tap Add Group, name Group and submit.

Add contacts to Group: add the contacts to the group

Method 1: Tap the Group on Group interface, to enter any group. You can tap Add Person to add contacts into this group. It will jump to contact list of Local Contacts and Mobile Contacts, can tick the box on the right side of each contact, to add into

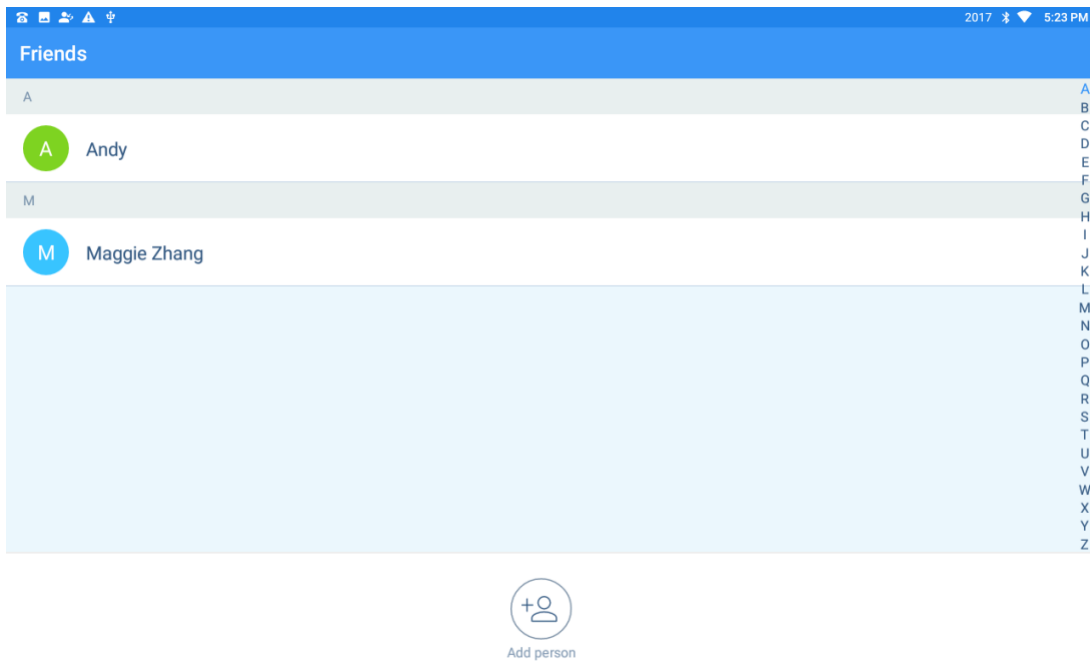
the group. Tap Add Person icon  to submit. Picture shows as below.



Method 2: Enter Local Contacts or Mobile Contacts, tap Edit icon  on each contact detail interface, tap the Groups option Add to Group to add this contact to any group. Please remember to submit it by  on top right side.

5.2.6 Blacklist and White List

Tap the Blacklist or Whitelist on Contacts, can enter the configuration interface. Please learn it on 4.3.2.3.

5.2.7 Contacts Operating Options

5.2.7.1 Contact Search

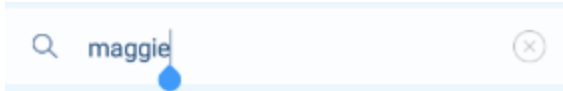
On contact interface, tap the search bar  to

search the contacts. You can enter the initial letter of contact/number to search. Device will show the searching reason when filling in the searching content. The searching range is covering Enterprise Contacts, Local Contacts, Mobile Contacts.

After entering and search on the Enterprise Contacts interface, Mobile Contacts interface, Favorite Contacts interface or Group interface, the searching range will be only on current interface.

You can also search on the dialer interface. Enter the Dialer, fill number or name in box, then the search result will be showed on the left side.

5.2.7.2 Long Press the Contact

Long press the contacts in Local Contacts and Mobile Contacts, will pop up the Add into Blacklist, Create Shortcut, Delete Contact. In Enterprise Contacts, there is no option to delete the contacts, because there is not allowed to add/modify/delete the contacts by normal users.

Add to Blacklist: Because there may be several numbers under on contact, after tap Add to Blacklist, device will pop up a box for double confirm and edit.

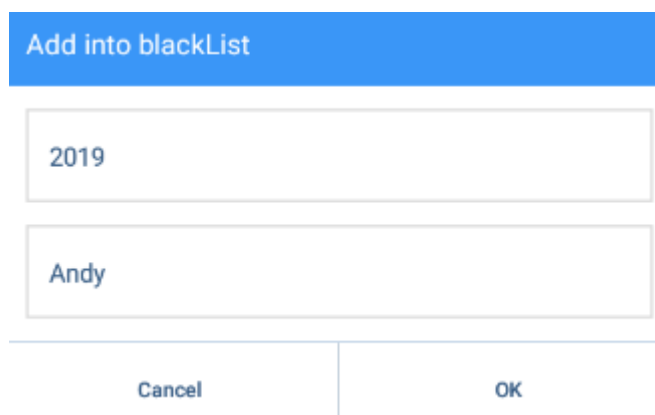

Create Shortcut: tap Create Shortcut to add this contact shortcut onto the device

desktop. Can follow the step on 4.1.3.

Delete Contacts: can delete contacts you select.

5.3.7.3 Long Press the Contact Number

Enter Enterprise Contacts, Mobile Contacts or Local Contacts, tap any contact to call out. If long press the contact number, will pop up some options, like Add into Blacklist, Add into Whitelist, Edit before Call.

Choose Add into Blacklist/Whitelist, can put this contact into black list or white list.

Edit before Call, can edit number before video call or audio call.

5.3 Other Application

5.3.1 One-key to Lock

Tap the Lock icon, to one-key lock device.

5.3.2 File Manager

Can manage the files in device local storage, USB disk, SD card, etc. Can view, delete, copy, paste, re-name the files. Device will show  on the top left side when insert the U disk

1. Open the File Manager, enter the device storage interface.
2. Open the File Manager, Right slide to enter the U disk storage or SD card storage. Picture shows as below.

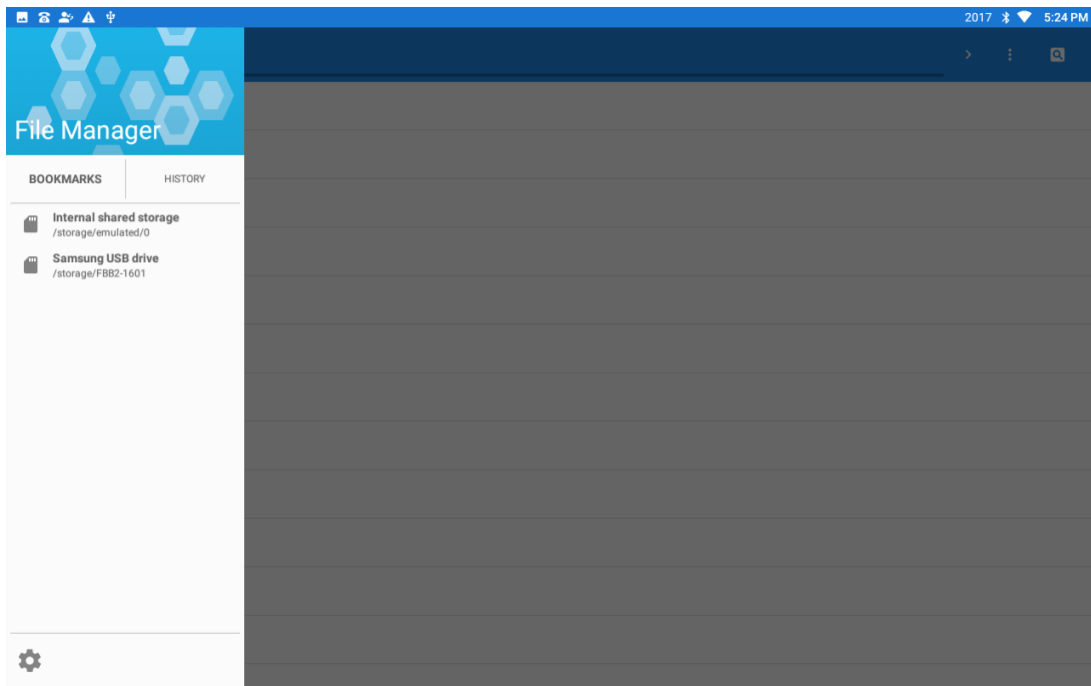

3. Open the File Manager, there is an operating option on the right side of each file and folder, tick it to operate.
4. Tick any file or folder to enter other file manager, tap the icon  on the top right side, can operate on pop-up options, including deselect, etc.

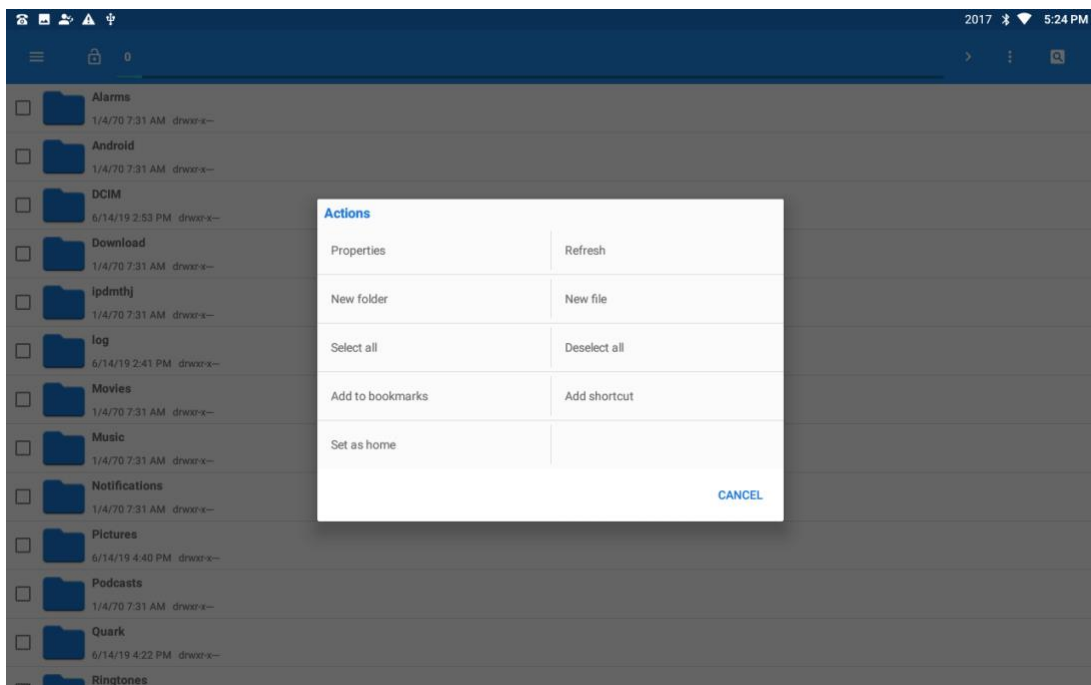

5. Tap the searching icon  on top right side, can search files

5.3.3 Gallery

You can view the pictures using the Gallery App, picture shows as below:

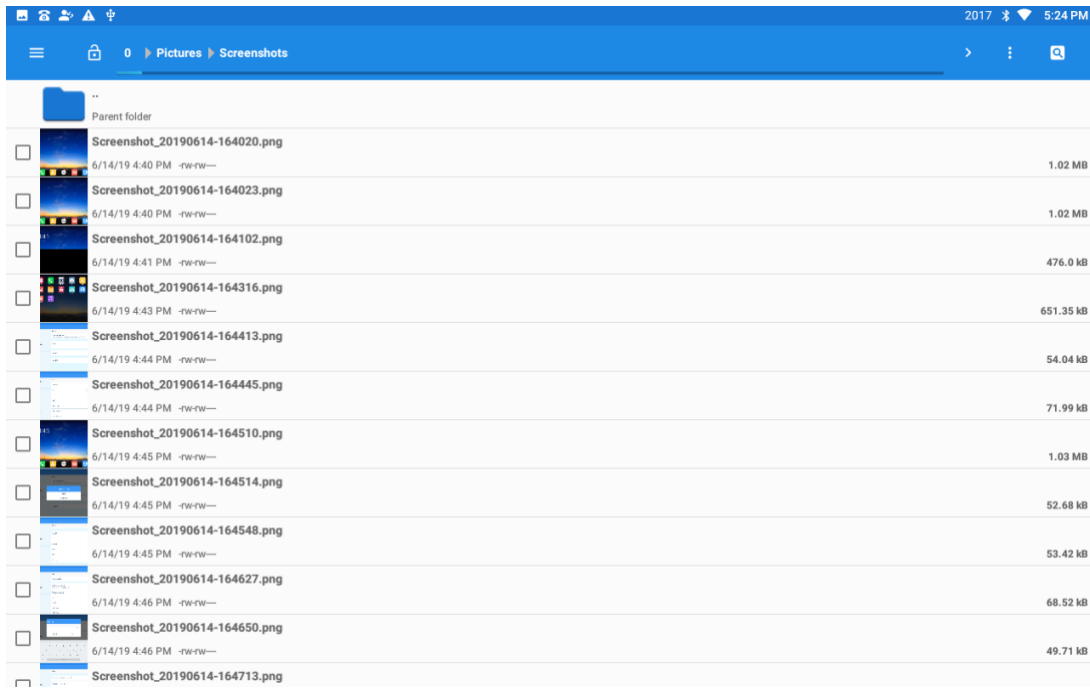

5.3.4 Input Method Editor

Tap any input box on device LCD screen, the input method editor will show up.

In the first time, need to make some modify basing on your use habits. There are 26-keys or 9-keys keyboard type in English input. Picture shows as below.

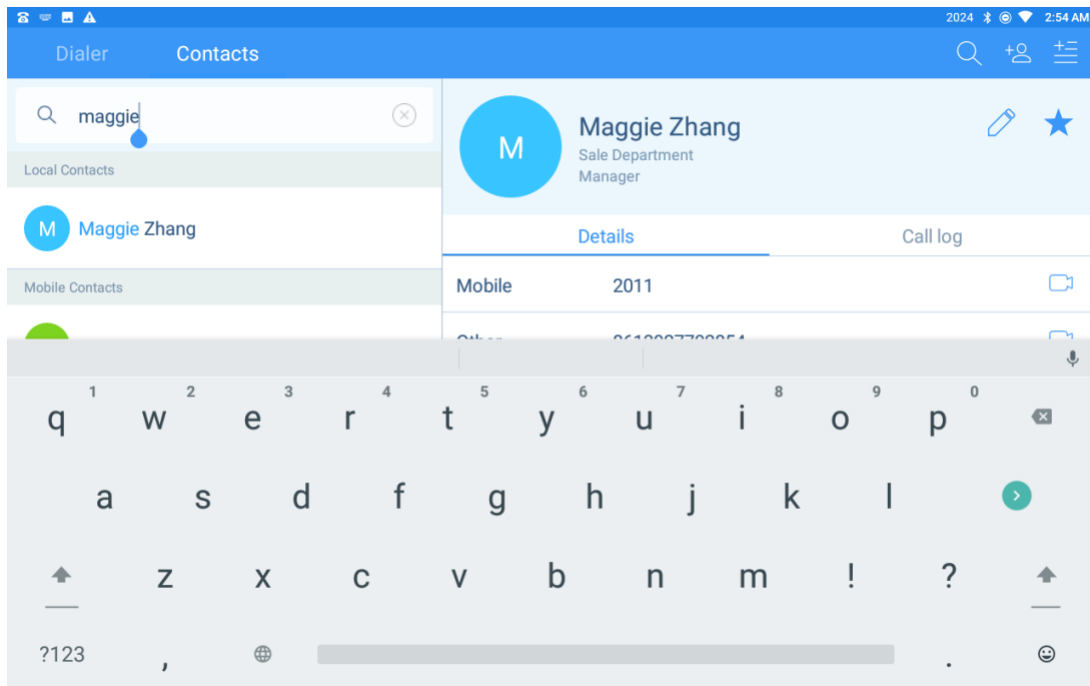

5.3.5 Install Third-party Application

This is special for system integrators or software developers.

This device is supported to install third-party application to meet different needs, and value-adding for various industries. You can install application by browser, USB, SD card, etc. Before install application, please enable the Unknown source installation.

Enable to install application on WEB: Log in WEB GUI, enter Menu: Maintain—Other, to enable the Install Application.

Enable the Unknown Sources on device: Tap Setting—Advanced Setting—Developers options—Security—Unknown source, enable it.

After above, please install application into the device.

6 FAQ

1. How to open Web Management (VOIP phone only)

Step 1 : Connect the Wan interface of the phone to your office network.

Step 2: Find the IP of the Phone. (In drop down menu or Setting—About device)

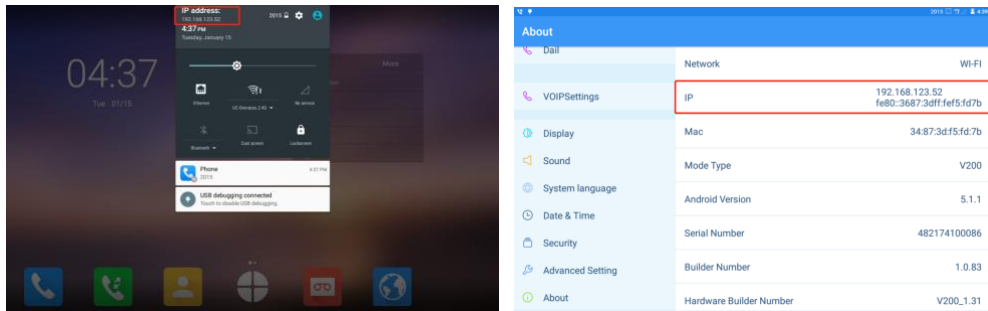

Step 3: Open the IP address link in your PC browser.

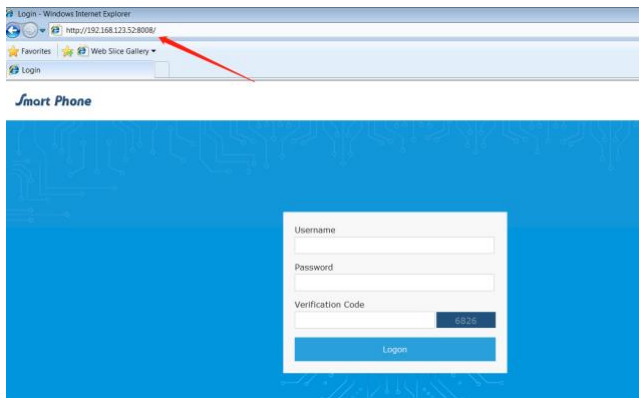

Step 4: Fill in the username and password **superadmin/psw.v1v2v3**
(Old version: superadmin/psw.phone)

2. How to enable software installation.

VOIP version :

Step 1 : Open Web Management—Maintenance—Others—Application Installation--Enable

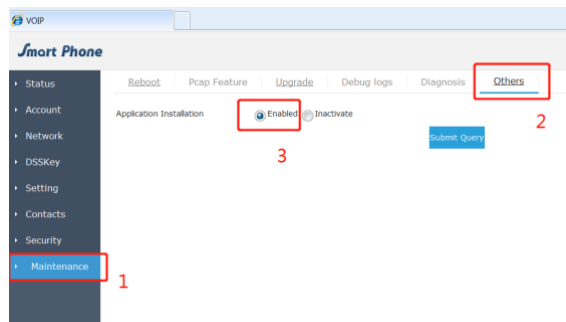

Step 2: Enable unknow sources. (Setting—Advanced Setting—Developers Options—Security)

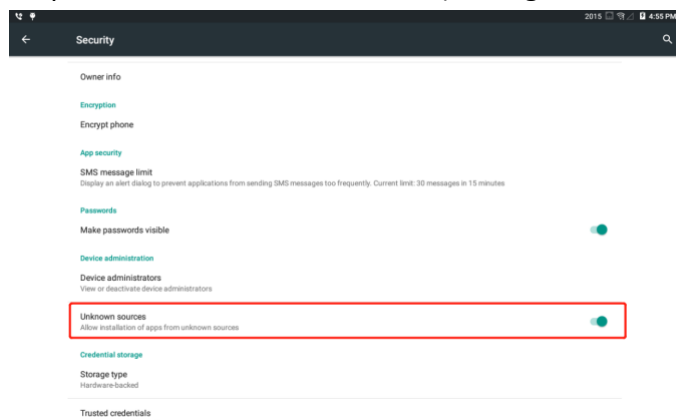

PSTN Version :

Step1: Get preparation for adb tool.



adb.rar

Put (file attached here, right click and copy it to your PC) into your **administrator**



account folder.

Then decompress the adb.rar to root directory.

The adb.exe in windows users folder.

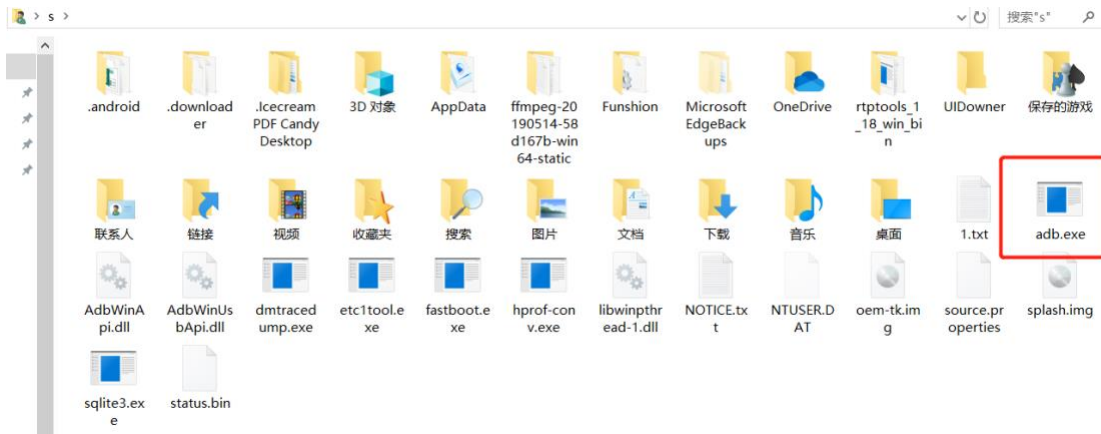

Step 2: Enable usb debug mode on phone (**Need to reboot**)

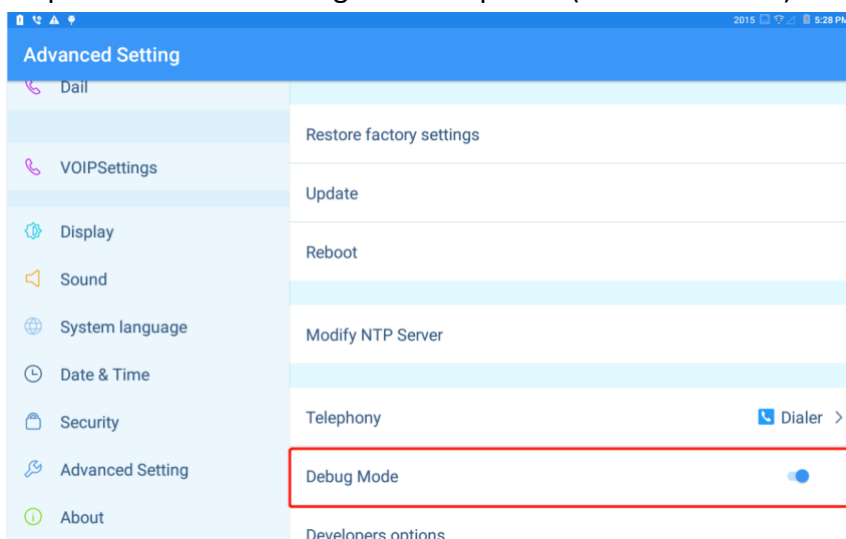

Step 3: Open windows cmd.

And type in **adb devices**.

If phone connected via **USB debugging mode**, the SN code will be shown as below.

```
Microsoft Windows [版本 10.0.17763.615]
(c) 2018 Microsoft Corporation。保留所有权利。

C:\Users\s>adb devices
List of devices attached
9f8e6aa7    device

C:\Users\s>_
```

Step 4: Type in the command

adb shell setprop rw.telpo.isAllowInstall true

Step 5: Enable unknow sources. (Setting –Advanced Setting—Developers Options—Security)

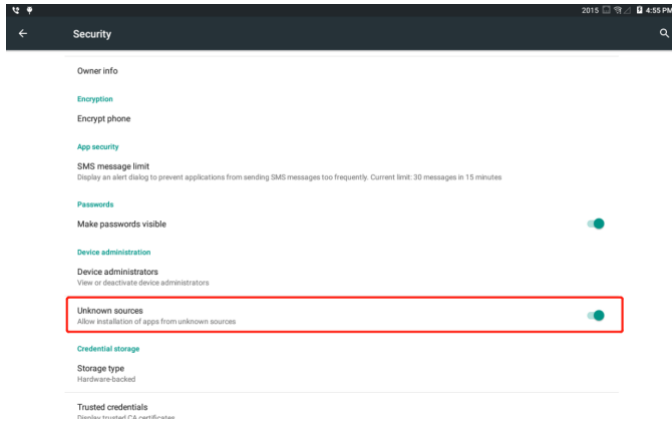

3. How to install an application.

Method 1: Install via Web (VOIP version only)

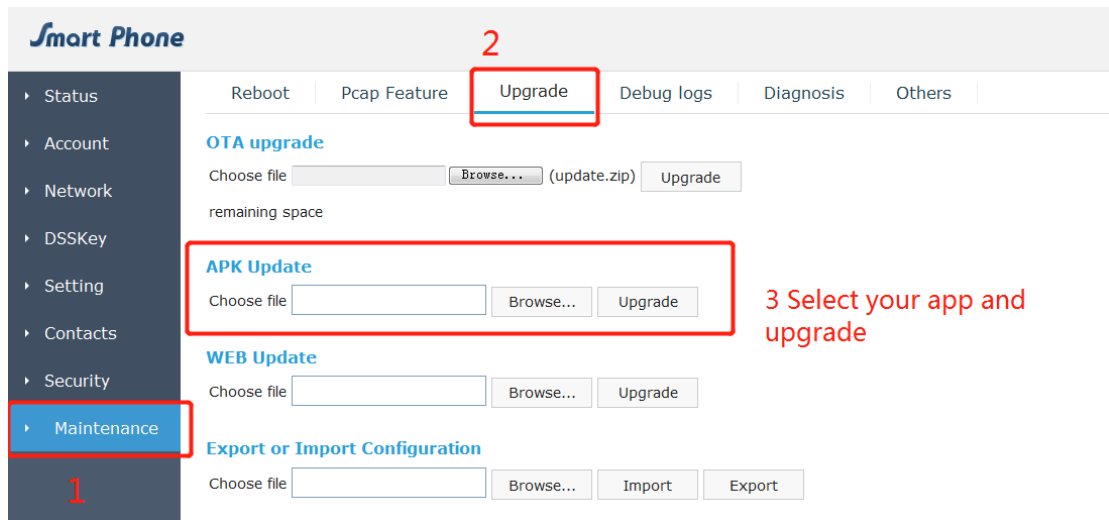

Method 2: Install via USB disk.

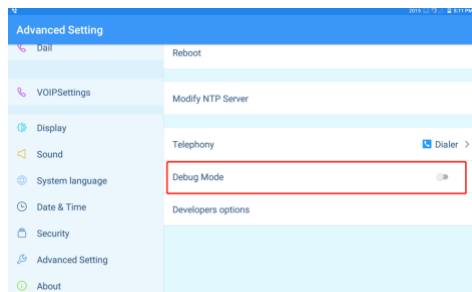

1. USB debug mode off

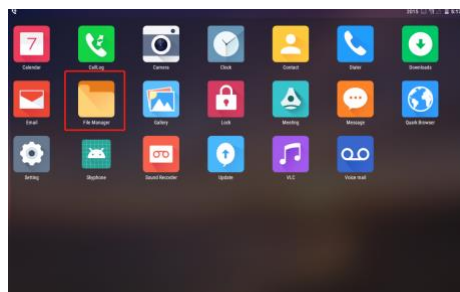

2. Open file manager

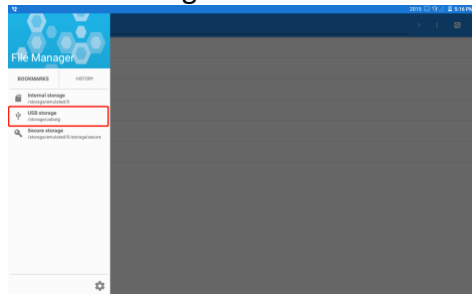

2. Select USB storage

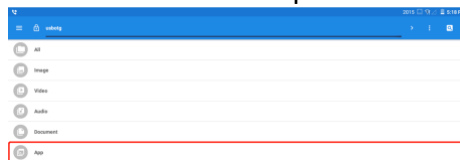

4. Install your app

Method 3: install via adb tool

adb install app

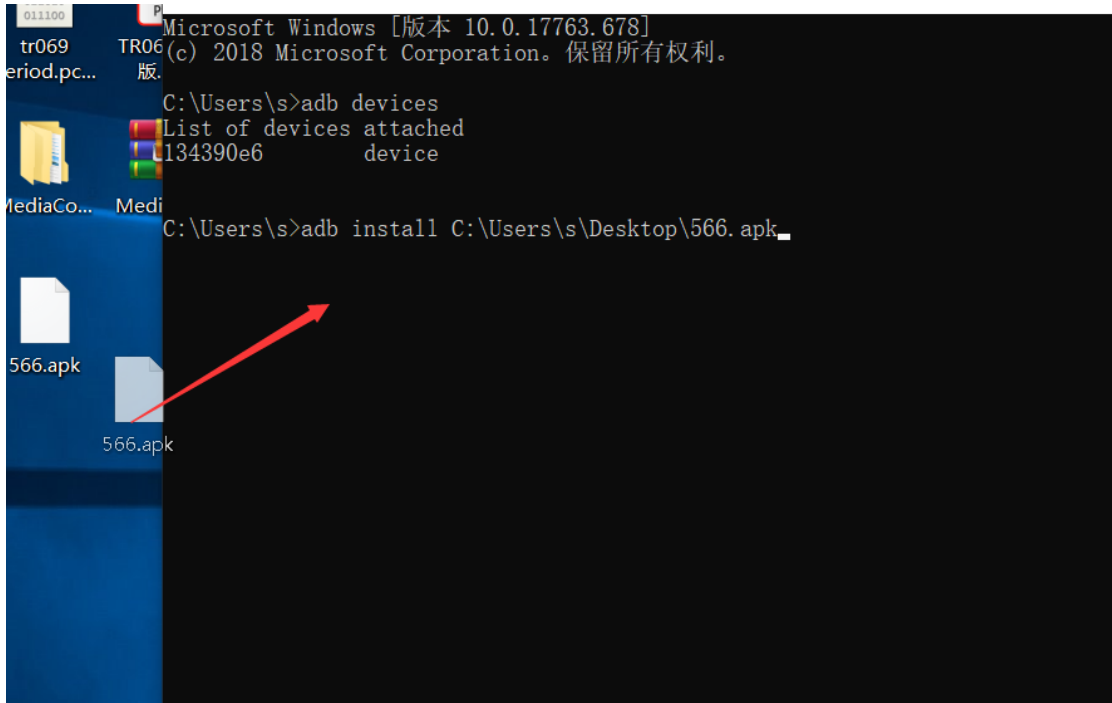

You can drag the app into the cmd window after typed in “adb install “

Method 4: Download the app from phone web browser, and then install app.

4. Wan and Lan Interfaces are not working

Reason: Debug mode is on.

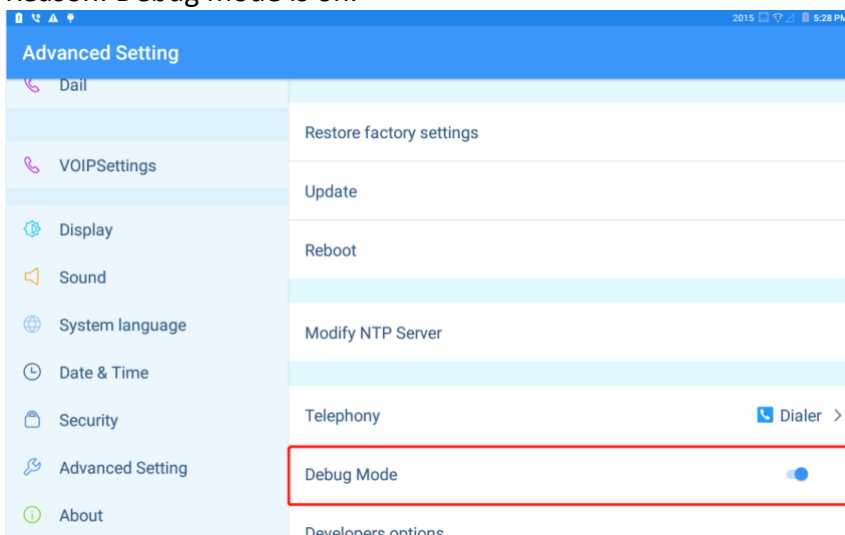

Debug mode on: USB debugging is on, Wan/Lan down.

Debug mode off: USB storage connection enable, Wan/Lan up.

5. How to Set up Sip Account

a) Set up in phone (Password 123456)

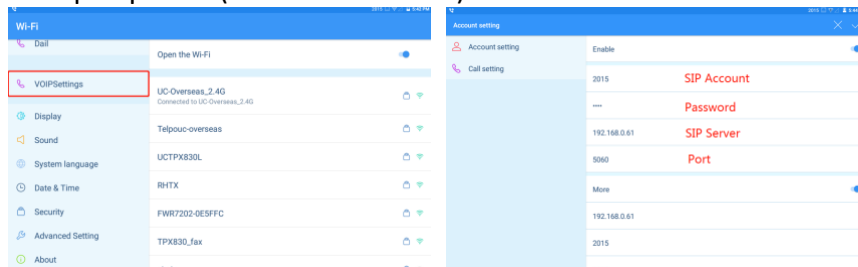

b) Set up in Web management

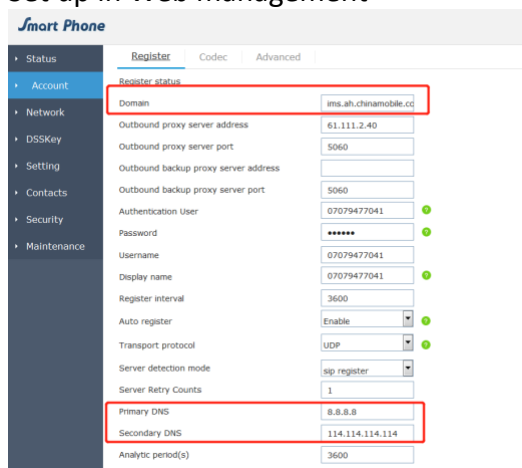

When using the domain name type SIP account from ims, you must fill in the DNS address.